

## AVQ400-48S12PB-6LS

**420 Watts**  
**Quarter-brick Converter**

**Total Power:** 420 Watts  
**Input Voltage:** 36 to 75 Vdc  
**# of Outputs:** Single

### Special Features

- Delivering up to 35A output
- Ultra-high efficiency 93% typ. at full load
- Wide input range: 36V ~ 75V
- Excellent thermal performance
- No minimum load requirement
- RoHS 6 compliant
- Basic isolation
- High power density
- Low output noise
- Improved thermal performance
- Remote output sense
- Input under voltage lockout
- Output over current protection
- Output over voltage protection
- Over temperature protection
- Industry standard quarter-brick pin-out outline
- Open frame or baseplate optional
- Remote control logic optional
- Pin length optional

### Safety

IEC/EN/UL/CSA 60950  
CE Mark  
UL/TUV

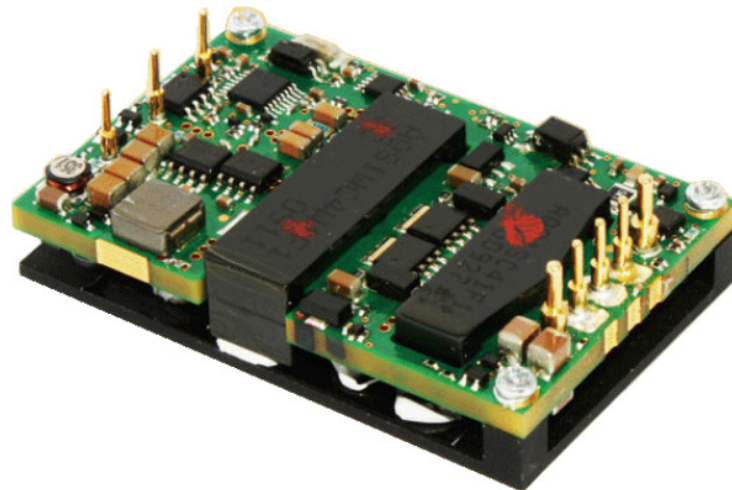

### Product Descriptions

The AVQ400-48S12PB-6LS is a single output DC/DC converter with standard quarter-brick outline and Above 93% ultra-high efficiency and excellent thermal performance makes it an ideal choice to used in telecom and datacom applications and can operate under an ambient temperature range of -40 °C ~ +85 °C.in configuration. It delivers up to 35A output current with 12V output voltage.

### Applications

Telecom/ Datacom

## Model Numbers

Standard	Output Voltage	Structure	Remote ON/OFF logic	RoHS Status
AVQ400-48S12BP-6LS	12Vdc	Baseplate	Positive	R6

## Ordering information

AVQ400	-	48	S	12	P	B	-	6	L	S
①		②	③	④	⑤	⑥		⑦	⑧	⑨

①	Model series	AVQ400: 400~420W high efficiency quarter-brick series
②	Input voltage	48: 36V ~ 75V input range, rated input voltage 48V
③	Output number	S: single output
④	Rated output voltage	12: 12V output
⑤	Remote ON/OFF logic	P: positive logic
⑥	Baseplate	B: baseplate; default: no baseplate
⑦	Pin length	6: 3.8mm ± 0.25mm
⑧	RoHS status	L: RoHS, R6
⑨	Customer code	S: Samsung

## Options

None

## Electrical Specifications

### Absolute Maximum Ratings

Stress in excess of those listed in the “Absolute Maximum Ratings” may cause permanent damage to the power supply. These are stress ratings only and functional operation of the unit is not implied at these or any other conditions above those given in the operational sections of this TRN. Exposure to any absolute maximum rated condition for extended periods may adversely affect the power supply’s reliability.

Table 1. Absolute Maximum Ratings:

Parameter	Model	Symbol	Min	Typ	Max	Unit
Input Voltage Operating -Continuous Non-operating -100mS	All	$V_{IN,DC}$	-	-	80	Vdc
	All		-	-	100	Vdc
Maximum Output Power	All	$P_{O,max}$	-	-	420	W
Isolation Voltage <sup>1</sup> Input to output Input to baseplate Output to baseplate	Open frame module		-	-	1500	Vdc
	Baseplate module		-	-	1500	Vdc
	Baseplate module		-	-	500	Vdc
Ambient Operating Temperature	All	$T_A$	-40	-	+85	°C
Storage Temperature	All	$T_{STG}$	-55	-	+125	°C
Voltage at remote ON/OFF pin	All		-0.7	-	12	Vdc
Humidity (non-condensing) Operating Non-operating	All		-	-	95	%
			-	-	95	

Note 1 - 1mA for 60s, slew rate of 1500V/10s

## Input Specifications

Table 2. Input Specifications:

Parameter	Conditions <sup>1</sup>	Symbol	Min	Typ	Max	Unit
Operating Input Voltage, DC	All	$V_{IN,DC}$	36	48	75	Vdc
Turn-on Voltage Threshold	$I_O = I_{O,max}$	$V_{IN,ON}$	-	35	36	Vdc
Turn-off Voltage Threshold	$I_O = I_{O,max}$	$V_{IN,OFF}$	31.8	34	-	Vdc
Lockout Voltage Hysteresis	$I_O = I_{O,max}$		1	-	3	V
Maximum Input Current ( $I_O = I_{O,max}$ )	$V_{IN,DC} = 36V_{DC}$	$I_{IN,max}$	-	-	13.6	A
No-load input current	$I_O = 0A$	$I_{IN}$	-	-	0.2	A
Standby Input current	Remote OFF	$I_{IN}$	-	0.01	0.1	A
Inrush current transient rating	All		-	-	1	A <sup>2</sup> s
Recommended Input Fuse	Fast blow external fuse recommended		-	-	15	A
Input filter component values (C\L)	Internal values		-	8.8\0.68	-	$\mu F\backslash\mu H$
Recommended External Input Capacitance	Low ESR capacitor recommended	$C_{IN}$	100	-	-	$\mu F$
Input Reflected Ripple Current	Through 12 $\mu H$ inductor		-	-	150	mA
Operating Efficiency	$T_A = 25^\circ C$ $I_O = I_{O,max}$ $I_O = 50\%I_{O,max}$	$\eta$	92.2 94	93 95	- -	% %

Note 1 -  $T_a = 25^\circ C$ , airflow rate = 400 LFM,  $V_{in} = 48V_{dc}$ , nominal  $V_{out}$  unless otherwise noted.

## Output Specifications

Table 3. Output Specifications:

Parameter	Conditions <sup>1</sup>	Symbol	Min	Typ	Max	Unit	
Factory Set Voltage	$V_{IN,DC} = 48V_{DC}$ $I_O = I_{O,max}$	$V_O$	11.80	12	12.20	Vdc	
Output Voltage Line Regulation	All	$\%V_O$	-	-	0.2	%	
Output Voltage Load Regulation	All	$\%V_O$	-	-	0.5	%	
Output Voltage Temperature Regulation	All	$\%V_O$	-	-	0.02	$\%/^{\circ}C$	
Total output voltage range (Over sample, line, load, temperature & life)	All	$V_O$	11.8	12	12.2	V	
Output Ripple, pk-pk	20MHz bandwidth	$V_O$	-	-	150	$mV_{PK-PK}$	
Operating Output Current range	All	$I_O$	0	-	35	A	
Output DC current-limit inception <sup>2</sup>		$I_O$	36.75	-	45.5	A	
$V_O$ Load Capacitance <sup>3</sup>	All	$C_O$	470	1000	10000	$\mu F$	
$V_O$ Dynamic Response	Peak Deviation Settling Time	50% ~75%~50% slew rate = 0.1A/us	$\pm V_O$	-	-	600	mV
		$T_s$	-	-	700	$\mu Sec$	
		50% ~75%~50% slew rate = 1A/us	$\pm V_O$	-	-	1200	mV
			$T_s$	-	-	700	$\mu Sec$
Turn-on transient	Rise time	$I_O = I_{max}$	$T_{rise}$	-	-	100	mS
	Turn-on delay time	$I_O = I_{max}$	$T_{turn-on}$	-	-	150	mS
	Output voltage overshoot	$I_O = 0$	$\%V_O$	-	-	5	%
Switching frequency	All	$f_{sw}$	130	140	150	KHz	

Note 1 -  $T_a = 25^{\circ}C$ , airflow rate = 400 LFM,  $V_{in} = 48V_{dc}$ , nominal  $V_{out}$  unless otherwise noted.

Note 2 - Hiccup: auto-restart when over-current condition is removed.

Note 3 - High frequency and low ESR is recommended.

## Output Specifications

Table 3. Output Specifications, con't:

Parameter		Conditions <sup>1</sup>	Symbol	Min	Typ	Max	Unit
Remote ON/OFF control (positive logic)	Off-state voltage	All		-0.7	-	1.2	V
	On-state voltage	All		3.5	-	12	V
Remote ON/OFF control (negative logic)	Off-state voltage	All		3.5	-	12	V
	On-state voltage	All		-0.7	-	1.2	V
Output over-voltage protection <sup>4</sup>		All	V <sub>O</sub>	13	-	16	V
Output over-temperature protection <sup>5</sup>		No baseplate	T	-	125	-	°C
		Baseplate		108	110	114	°C
Over-temperature hysteresis		All	T	-	5	-	°C
MTBF		Telcordia SR-332-2006; 80% load, 300LFM, 40°C T <sub>a</sub>		-	1.5	-	10 <sup>6</sup> h

Note 4 - Hiccup: auto-restart when over-voltage condition is removed.

Note 5 - Auto recovery.

## AVQ400-48S12 Performance Curves

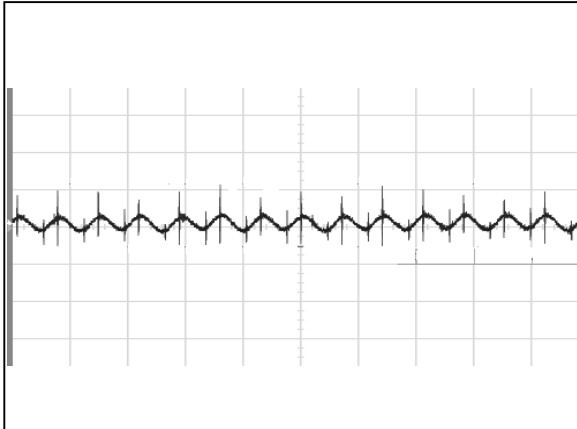

Figure 1: AVQ400-48S12 Input Reflected Ripple Current Waveform (5 $\mu$ S/div, 20mA/div)

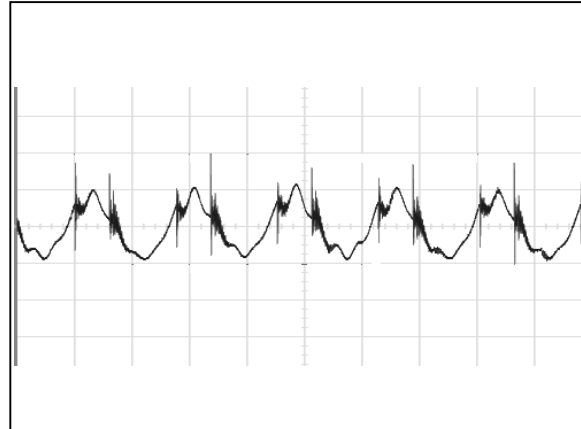

Figure2: AVQ400-48S12 Ripple and Noise Measurement (2 $\mu$ S/div, 16mV/div)

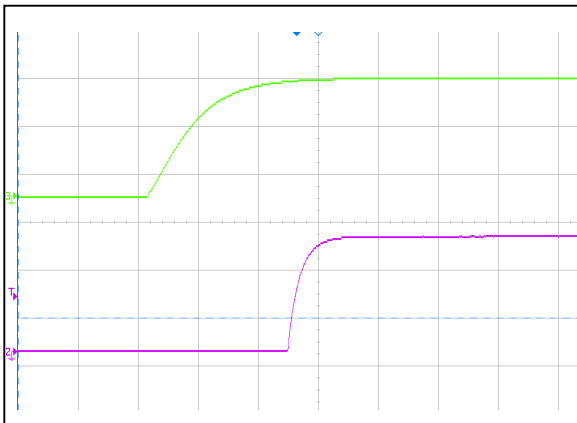

Figure 3: AVQ400-48S12 Output Voltage Startup Characteristic (50mS/div)

Ch 2: Vo (5V/div)

Ch 3: Vi (20V/div)

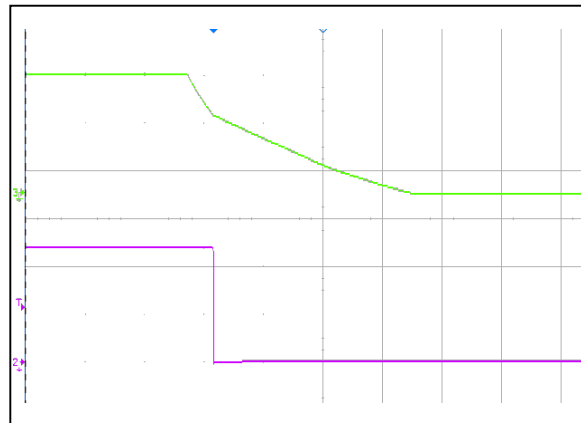

Figure 4: AVQ400-48S12 Turn Off Characteristic (100mS/div)

Ch 2: Vo (5V/div)

Ch 3: Vi (20V/div)

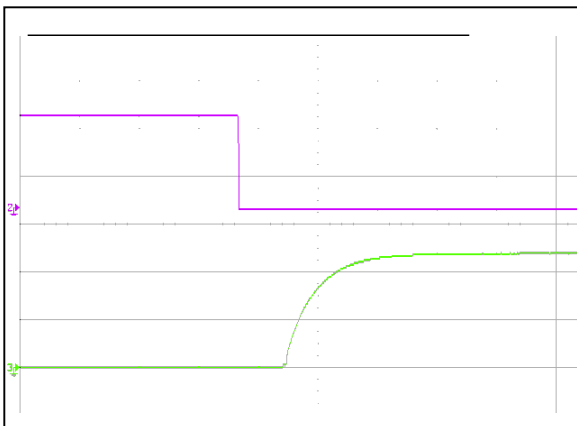

Figure 5: AVQ400-48S12 Remote ON Waveform (20mS/div)

Ch 3: Vo (5V/div)

Ch 2: Remote ON (2V/div)

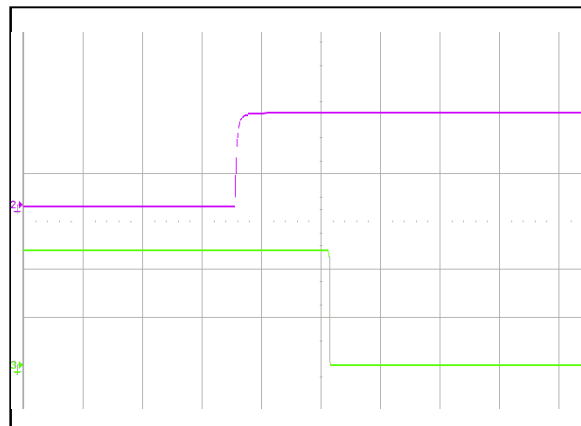

Figure 6: AVQ400-48S12 Remote OFF Waveform (10mS/div)

Ch 3: Vo (5V/div)

CH 2: Remote OFF (2V/div)

## AVQ400-48S12 Performance Curves

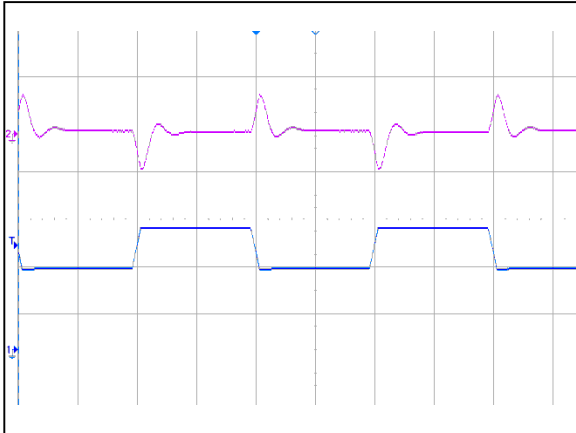

Figure 7: AVQ400-48S12 Transient Response (500uS/div)  
 50%~75%~50% load change, 0.1A/uS slew rate  
 Ch 2: Vo (500mV/div) Ch 1: Io (10A/div)

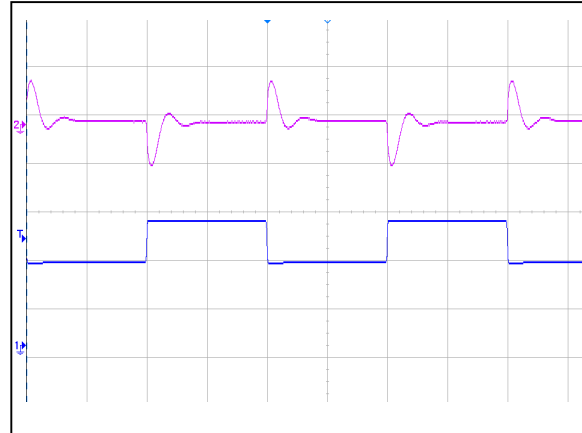

Figure 8: AVQ400-48S12 Transient Response (500uS/div)  
 50%~75%~50% load change, 1A/uS slew rate  
 Ch 2: Vo (500mV/div) Ch 1: Io (10A/div)

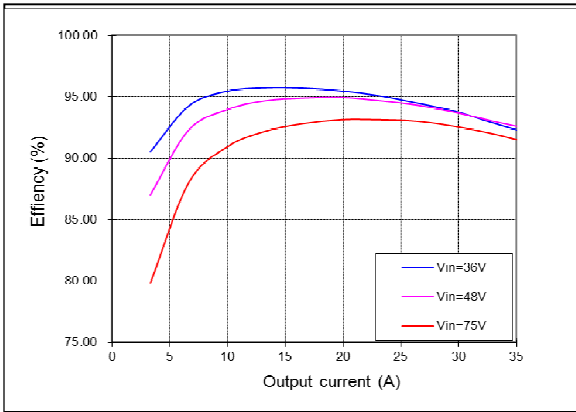

Figure 9: AVQ400-48S12 Efficiency Curves @ 25 °C, Vo=12V

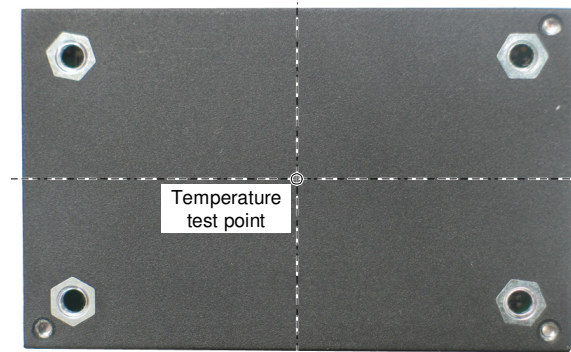
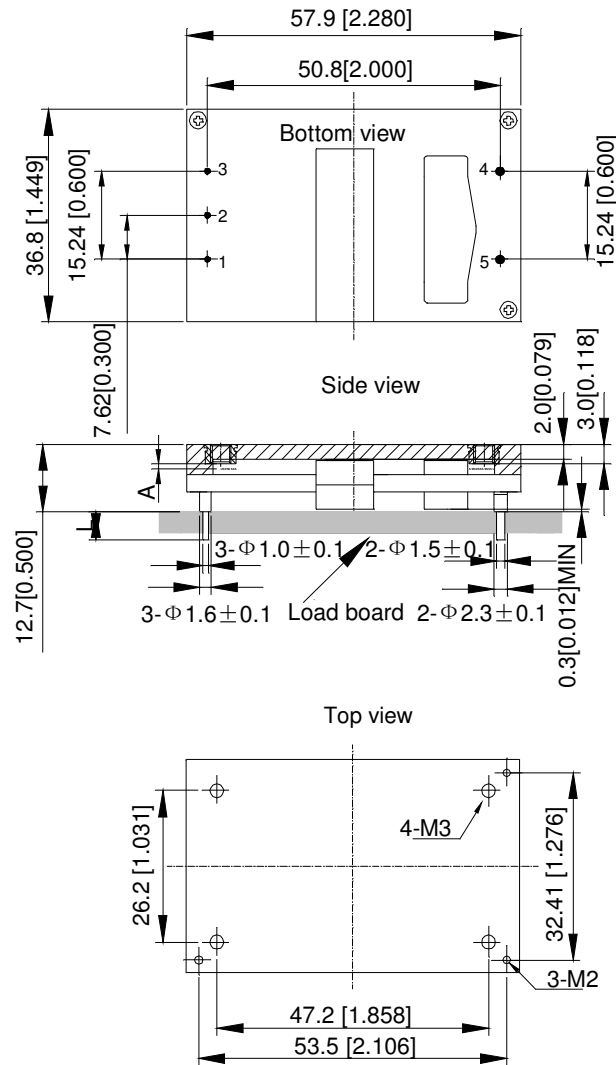

Figure 10 Baseplate model OTP test point



## Mechanical Specifications

### Mechanical Outlines – Baseplate Module



Unit: mm[inch] Bottom view: pin on upside

Tolerance: X.Xmm ± 0.5mm[X.X in. ± 0.02in.]

X.XXmm ± 0.25mm[X.XX in. ± 0.01in.]

Screws connected customer's heatsink with power module's heatsink protrude nuts

A	1.0mm max
---	-----------

## Pin Length Option

Device code suffix	L
-4	4.8mm ± 0.25 mm
-6	3.8mm ± 0.25 mm
-8	2.8mm ± 0.25 mm
None	5.8mm ± 0.25 mm

## Pin Designations

Pin No	Name	Function
1	$V_{in+}$	Positive input voltage
2	CNT	Remote ON/OFF control
3	$V_{in-}$	Negative input voltage
4	$V_{o-}$	Negative output voltage
5	$V_{o+}$	Positive output voltage

## Environmental Specifications

### **EMC Immunity**

AVQ400-48S12 Series power supply is designed to meet the following EMC immunity specifications:

Document	Description	Criteria
EN55022	Conducted emission, DC Input, Class B limit	/
IEC/EN 61000-4-2, Level 3	ESD, Enclosure port	B
IEC/EN 61000-4-6, Level 2	Conducted disturbances immunity, DC Input	A
IEC/EN 61000-4-4, Level 3	EFT	B
IEC/EN 61000-4-5	Surges, DC Input Line to Ground(earth): 600V, Line to Line: 600V, System reset is not allowed	B
EN61000-4-29	DC voltage dips, short interruption, variation, DC Input	B

Criterion A: Normal performance during and after test.

Criterion B: Temporary output voltage fluctuation ceases after disturbances ceases, and from which the EUT recovers its normal performance automatically. For EFT and surges, low-voltage protection or reset is not allowed. For dips and ESD, output voltage fluctuation or reset is allowed during the test, but recovers to its normal performance automatically after the disturbance ceases.

Criterion C: Temporary loss of output, the correction of which requires operator intervention.

Criterion D: Loss of output which is not recoverable, owing to damage to hardware.

## EMC Test Configuration

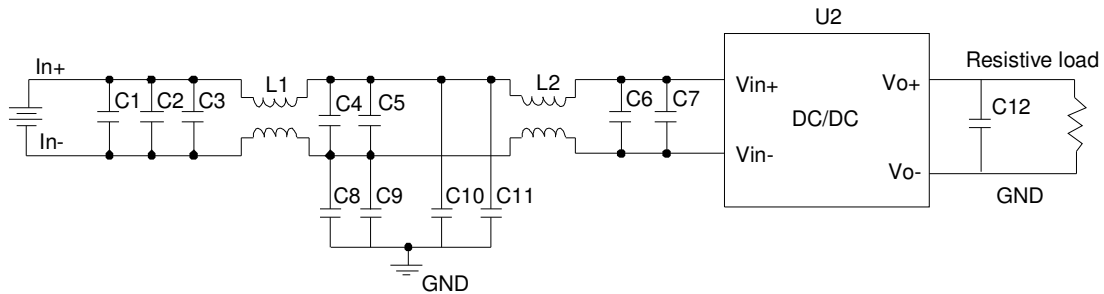

Figure 11 EMC test configuration

U2: Module to test, AVQ400-48S12

C1~C5: SMD ceramic capacitor-100V-1000nF-X7R-1210

C6: SMD ceramic capacitor-100V-100nF-±10%-X7R-1206

L1, L2: Common mode inductor-single phase-473μh-±25%-14A magnetic ring 1mm × 25.4mm × 12.7mm-working temperature range includes module temperature rise. Temperature rises at rated current: 55°C (max.)

C8~C11: High-voltage chip ceramic capacitor. Capacitance: 0.22U/630V/X7R. Size: 2220. Capable of withstanding 1kV voltage

C7: Input electrolytic capacitor, according to the same type as C1 in Figure 14.

C8: Output electrolytic capacitor, according to the same type as C3 in Figure 14.

## **Safety Certifications**

The AVQ400-48S12 Series power supply is intended for inclusion in other equipment and the installer must ensure that it is in compliance with all the requirements of the end application. This product is only for inclusion by professional installers within other equipment and must not be operated as a stand alone product.

Table 4. Safety Certifications for AVQ400-48S12 series power supply system

<b>Document</b>	<b>File #</b>	<b>Description</b>
UL60950		US and Canada Requirements
EN60950-1		European Requirements
IEC60950		International Requirements
CE		CE Marking
UL94		V-0 flammability rating

**Operating Temperature**

The AVQ400-48S12 series power supplies will start and operate within stated specifications at an ambient temperature from -40 °C to 85 °C under all load conditions. The storage temperature is -55 °C to 125 °C.

**Thermal Considerations - Baseplate Model**

The converter is designed to operate in different thermal environments and sufficient cooling must be provided. Proper cooling of the DC/DC converter can be verified by measuring the temperature at the test point as shown in the Figure 12.

The temperature at these points should not exceed the max values in the Table 5.

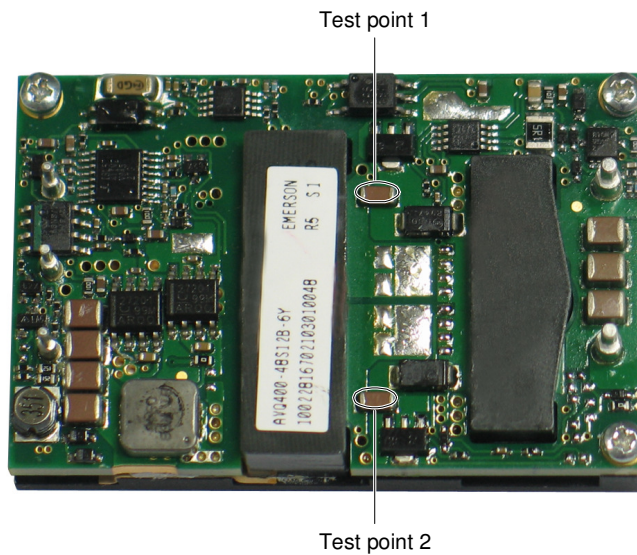

Temperature test points on FR-4 board

Figure 12 Baseplate model temperature test point on converter

Table 5. Temperature limit of the test points

Test Point	Temperature limit
Test point 1	118°C
Test point 2	118°C

**Thermal Considerations — Baseplate Model Con't**

The converter can operate with a smaller heatsink and sufficient airflow. Figure 13 shows the derating output current vs. ambient air temperature at different air velocities with a specified heatsink.

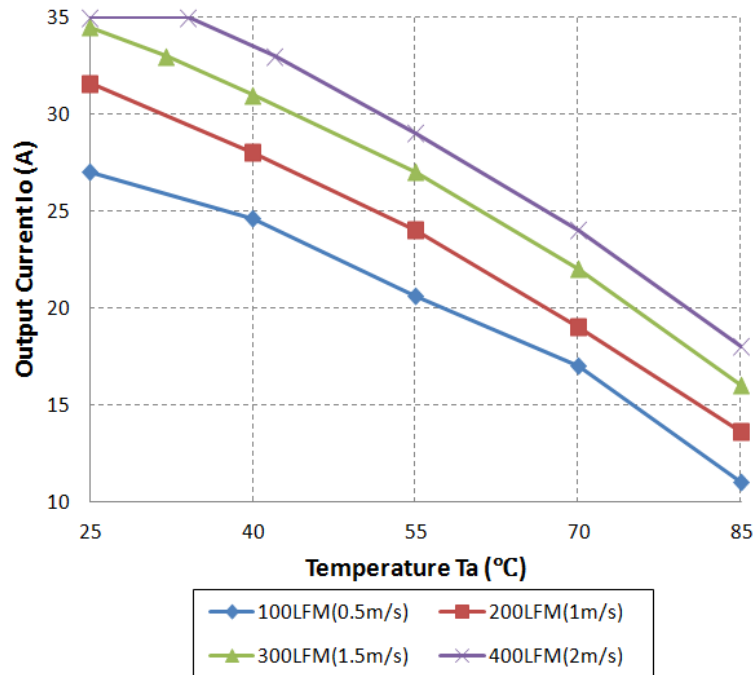

Figure 13 Output power derating, 48V<sub>in</sub>, air flowing across the converter from pin 1 to pin 3

## Qualification Testing

Parameter	Unit (pcs)	Test condition
Halt test	4-5	$T_{a,min} - 10\text{ }^{\circ}\text{C}$ to $T_{a,max} + 10\text{ }^{\circ}\text{C}$ , 5 $^{\circ}\text{C}$ step, $V_{in}$ = min to max, 0 ~ 105% load
Vibration	3	Frequency range: 5Hz ~ 20Hz, 20Hz ~ 200Hz, A.S.D: 1.0m <sup>2</sup> /s <sup>3</sup> , -3db/oct, axes of vibration: X/Y/Z. Time: 30min/axes
Mechanical Shock	3	30g, 6ms, 3axes, 6directions, 3time/direction
Thermal Shock	3	-40 $^{\circ}\text{C}$ to 100 $^{\circ}\text{C}$ , unit temperature 20cycles
Thermal Cycling	3	-40 $^{\circ}\text{C}$ to 55 $^{\circ}\text{C}$ , temperature change rate: 1 $^{\circ}\text{C}/\text{min}$ , cycles: 2cycles
Humidity	3	40 $^{\circ}\text{C}$ , 95%RH, 48h
Solder Ability	15	IPC J-STD-002C-2007



## Application Notes

### Typical Application

Below is the typical application of the AVQ400-48S12 series power supply.

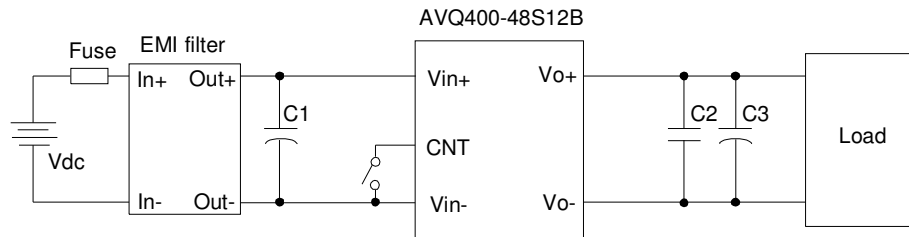

Figure 14 Typical application

C1: 100 $\mu$ F/100V electrolytic capacitor, P/N: UPW2A101MHD (Nichicon) or equivalent caps

C2: 1 $\mu$ F/100V X7R ceramic capacitor, P/N: C3225X7R2A105KT0L0U (TDK) or equivalent caps

C3: 1000 $\mu$ F/25V electrolytic capacitor, P/N: UPM1H102MHD (Nichicon) or equivalent caps

Fuse: External fast blow fuse with a rating of 15A. The recommended fuse model is 21612.5P from LITTLEFUSE.

## Remote ON/OFF

Positive remote ON/OFF logic is available in AVQ400-48S12PB-6LS. The logic is CMOS and TTL compatible. Figure 15 is the detailed internal circuit and reference in AVQ400-48S12PB-6LS.

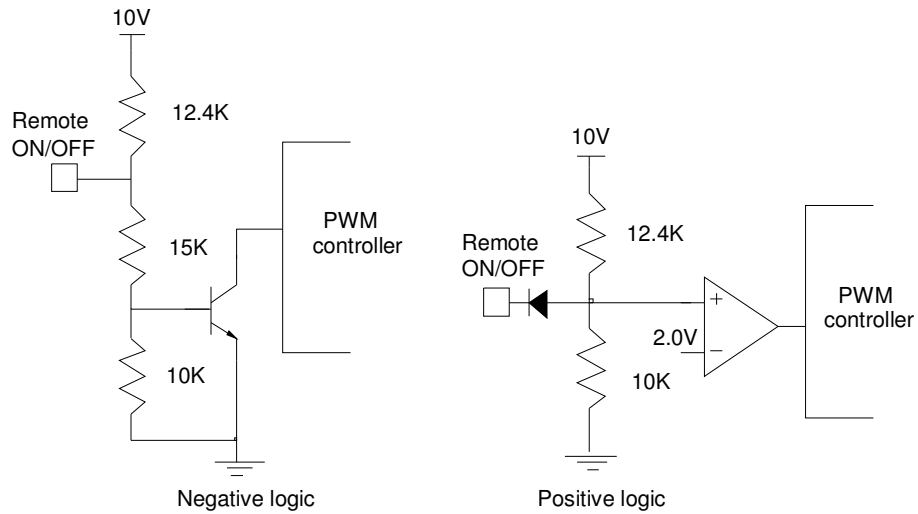

Figure 15 Remote ON/OFF internal diagram

The voltage between pin Remote ON/OFF and pin  $V_{in-}$  must not exceed the range listed in Table 3 to ensure proper operation. The external remote ON/OFF circuit is highly recommended as shown in Figure 18.

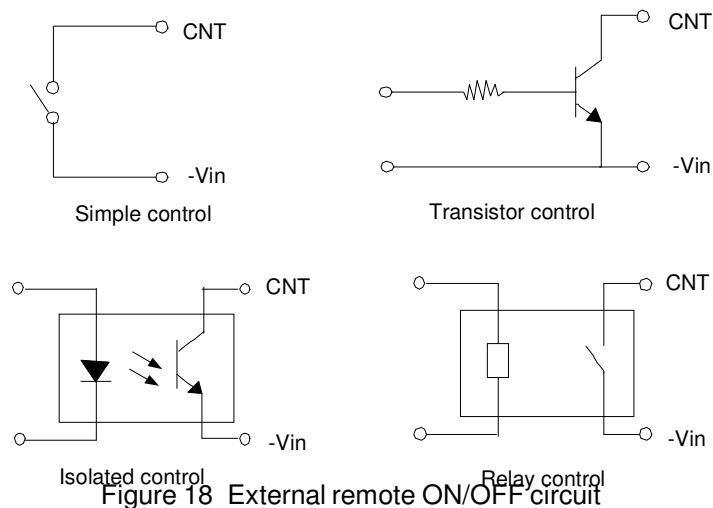

Figure 18 External remote ON/OFF circuit

**Input Ripple & Output Ripple & Noise Test Configuration**

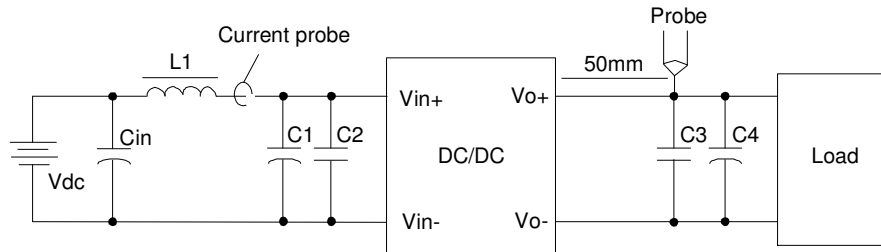

Figure 19 Input ripple & output ripple & noise test configuration

Vdc: DC power supply

L1: 12uH

Cin: 220uF/100V typical

C1: 100µF/100V electrolytic capacitor; P/N: UPW2A101MHD (Nichicon) or equivalent caps

C2 ~ C3: 1µF/100V X7R ceramic capacitor; P/N: C3225X7R2A105KT0L0U (TDK) or equivalent caps

C4: 1000µF/25V electrolytic capacitor; P/N: UPM1H102MHD (Nichicon) or equivalent caps

Note - It is recommended to use a coaxial cable with series 50Ω resistor and 0.68µF ceramic capacitor or a ground ring of probe to test output ripple & noise.

### **Soldering**

The product is intended for standard manual or wave soldering.

When wave soldering is used, the temperature on pins is specified to maximum 260 °C for maximum 7s.

When manual soldering by hand, the iron temperature should be maintained at 300 °C ~ 380 °C and applied to the converter pins for less than 10s. Longer exposure can cause internal damage to the converter.

Cleaning of solder joint can be performed with cleaning solvent IPA or similitive.

### **Assembly**

The maximum length of the screw driven into heatsink is 1.0mm.

**Hazardous Substances Announcement (RoHS of China R6)**

Parts	Hazardous Substances					
	Pb	Hg	Cd	Cr <sup>6+</sup>	PBB	PBDE
AVQ400-48S12BP-6LS	x	x	x	x	x	x

x: Means the content of the hazardous substances in all the average quality materials of the part is within the limits specified in SJ/T-11363-2006

√: Means the content of the hazardous substances in at least one of the average quality materials of the part is outside the limits specified in SJ/T11363-2006

Artesyn Embedded Technologies has been committed to the design and manufacturing of environment-friendly products. It will reduce and eventually eliminate the hazardous substances in the products through unremitting efforts in research. However, limited by the current technical level, the following parts still contain hazardous substances due to the lack of reliable substitute or mature solution:

1. Solders (including high-temperature solder in parts) contain plumbum.
2. Glass of electric parts contains plumbum.
3. Copper alloy of pins contains plumbum

## Record of Revision and Changes

Issue	Date	Description	Originators
1.0	08.26.2015	First Issue	K. Wang
1.1	09.08.2016	Updated the turn-off voltage threshold minimum from 32V to 31.8V	K. Wang

### WORLDWIDE OFFICES

#### Americas

2900 S.Diablo Way  
Tempe, AZ 85282  
USA  
+1 888 412 7832

#### Europe (UK)

Waterfront Business Park  
Merry Hill, Dudley  
West Midlands, DY5 1LX  
United Kingdom  
+44 (0) 1384 842 211

#### Asia (HK)

14/F, Lu Plaza  
2 Wing Yip Street  
Kwun Tong, Kowloon  
Hong Kong  
+852 2176 3333



[www.artesyn.com](http://www.artesyn.com)

While every precaution has been taken to ensure accuracy and completeness in this literature, Artesyn Embedded Technologies assumes no responsibility, and disclaims all liability for damages resulting from use of this information or for any errors or omissions. Artesyn Embedded Technologies, Artesyn and the Artesyn Embedded Technologies logo are trademarks and service marks of Artesyn Technologies, Inc. All other names and logos referred to are trade names, trademarks, or registered trademarks of their respective owners.  
© 2014 All rights reserved.

For more information: [www.artesyn.com/power](http://www.artesyn.com/power)  
For support: [productsupport.ep@artesyn.com](mailto:productsupport.ep@artesyn.com)