

# SL POWER SLE36 SERIES

Lean Line 36 Watts Family  
Class I External Power Supplies

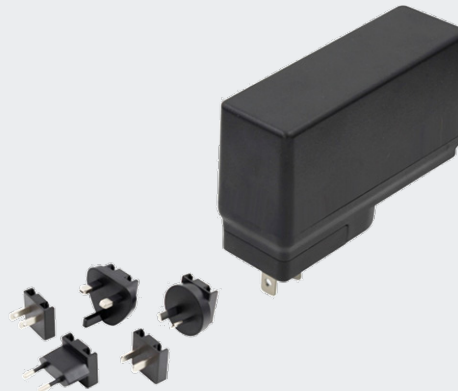

Medical



Industrial

LEAN  LINE

Advanced Energy's SL Power SLE36 series is approved to IEC/UL/EN 62368 and IEC/UL/EN 60601-1 safety standards and comply with the IEC 60601-1-2 4th edition collateral standard for electromagnetic disturbances. This series is well suited for ITE, multimedia, industrial and medical applications. Although IEC 60601-1-2 is a system level standard, the power adapter is the interface between the medical device and the AC power source and is an essential component in the path to achieving compliance to the standard.

The SLE36 series has leading edge power conversion efficiency to reduce component temperatures, extend product use life and reduce energy consumption. The SLE series adapters meet the U.S. Department of Energy (DoE) Level VI efficiency and no-load power consumption requirements. In addition SL Power has taken the lead in developing and providing IEC 60601-1-2 4th edition compliant power adapters.

The SLE24 series power supplies have enhanced Electro-Magnetic Compatibility (EMC) features offering increased Electro-Static Discharge (ESD) protection, AC mains surge and Radio Frequency (RF) immunity, resulting in a more robust and reliable product.

The SLE36 model's AC mains emissions comply with FCC & EN 55032 and 55011 Class B levels with margin. Output emissions for differential ripple and common mode voltage and current have been reduced to minimize system level Electro-Magnetic Interference (EMI) and system circuit interference.

This application note provides guidance for proper use, selection criteria, system design consideration and key performance data.

## PROPER USE

The external power supplies have high power conversion efficiency; however, they do rely on convection cooling to the surrounding environment (air) to prevent overheating or excessive internal and external surface temperatures. Therefore, there needs to be adequate access to ambient air to ensure proper thermal performance of the power supply.

- Do not cover the power supply with blankets, clothing, pillows, or any other poor thermal conductor.
- Do not immerse the power supply in any liquid.
- Avoid dropping the power supply on hard surfaces.
- Avoid impacting the case of the power supply with any hard object.
- Use the proper input cord (desktop version) for the power supply.
- Use a proper mating connector for connection to the output of the power supply.
- Do not exceed the power rating of the product.
- Do not place adapter on body parts. This is not considered an “applied part.” Surface temperatures increase with increased ambient temperature and loading.

## PERFORMANCE VERIFICATION

### Efficiency and No-load Power

When measuring efficiency, care must be taken to minimize input and output connection voltage drops, as these can significantly affect the results of the measurement.

### Load and Noise Filtering Capacitors

The external adapters have output filtering capacitors to minimize the switching frequency voltage ripple and noise that is an artifact of the switching power conversion process. However, additional end load capacitance might be needed, depending on the application. With an electronic circuit as the load, it is recommended to add ceramic capacitors (0.1 to 1  $\mu\text{F}$ ) for noise spike reduction and an electrolytic capacitor for ripple reduction and transient response voltage dip reductions. The amount of voltage dip during a transient is a function of the load step amplitude and rise/fall time of the load. The output of the power adapter is regulated in the adapter and does not compensate for the output cable voltage drop. The overall load regulation specified is measured at the adapter output connector, however.

### Output Ripple and Noise

Output noise and ripple limits are defined in the product datasheet and vary depending on the output voltage. Consult the product datasheet prior to assessing the output ripple and noise measurement results.

Noise measurements are made at the output connector with typically a 10  $\mu\text{F}$  electrolytic capacitor in parallel with a 0.1  $\mu\text{F}$  ceramic capacitor. Use a short tip oscilloscope voltage probe when making the measurement. This is required to eliminate measurement error due to impedance imbalance errors introduced by the scope probe ground lead length.

Common mode noise is an electrical signal that appears between either output and earth ground or chassis ground. This comes due to parasitic capacitance and inductive coupling in the power supply that couples electrical energy from the primary to the secondary or from the secondary to earth ground. Although the coupling is minimized by design and construction, it cannot easily be eliminated. Be aware of any special needs in the application for low common mode noise.

## PERFORMANCE VERIFICATION

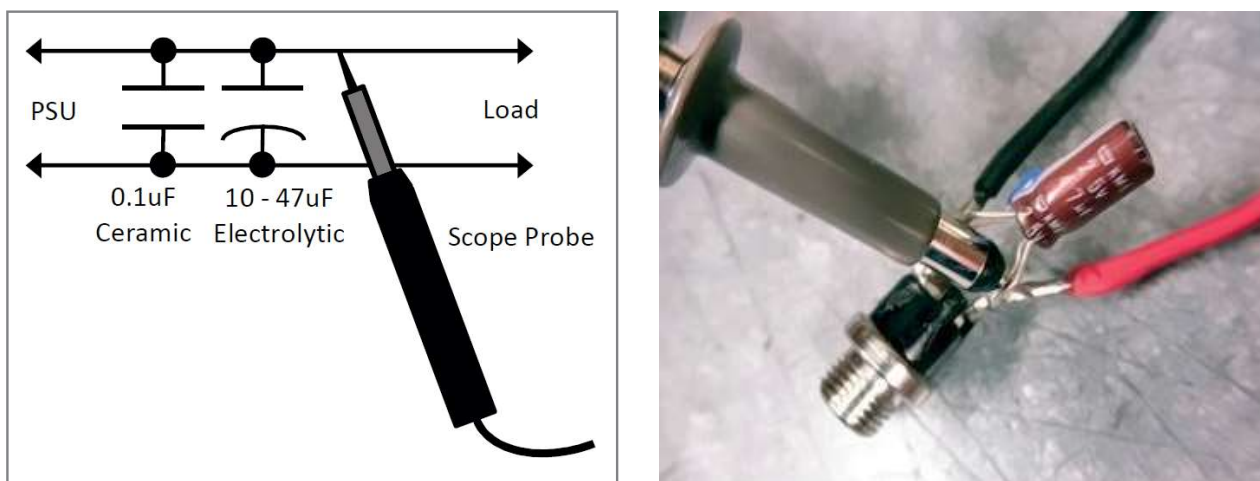

Figure 1: Noise measurement caps and probe with picture of the technique

**Thermal**

No special cooling requirements are needed other than operating within the specified operating temperature range and locating the external power adapter in an environment with unencumbered access to the room ambient air.

Adhere to the product datasheet derating curve when exposure to elevated temperatures is expected.

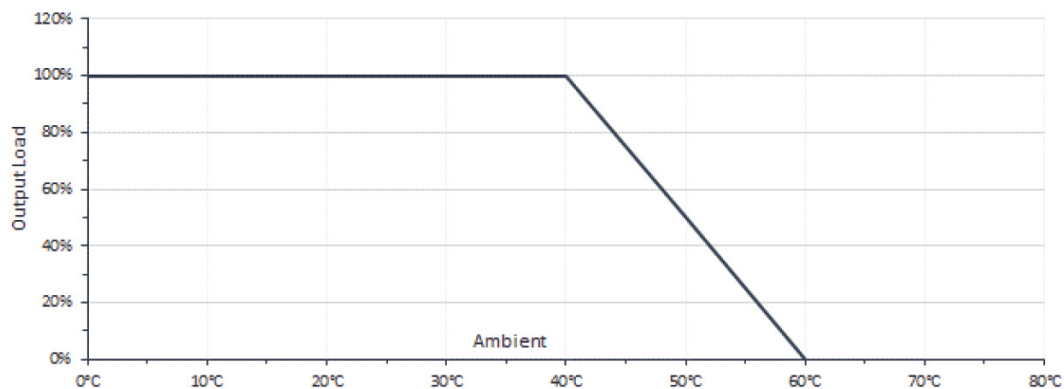
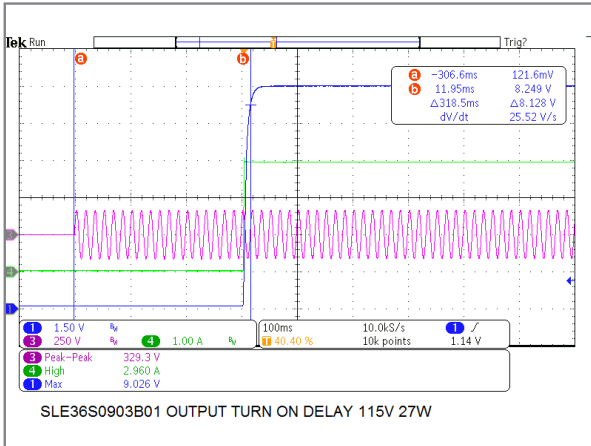

Figure 2: SLE36 family derating curve

PERFORMANCE DATA

Turn-on Delay

Start-up turn-on delay typical times at 115 VAC. The electronic load used for these plots was in constant current mode.



36W/9V Model Turn-On Delay Time

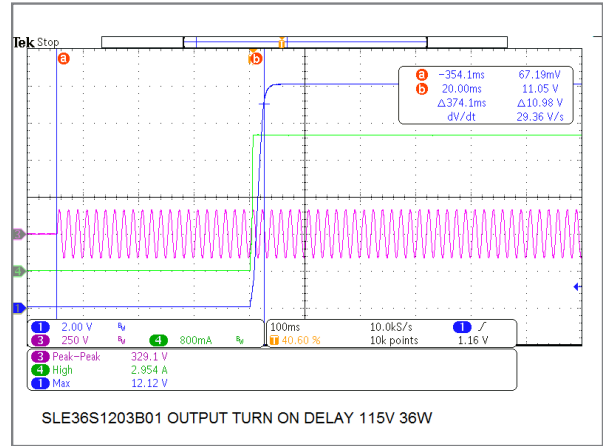

36W/12V Model Turn-On Delay Time

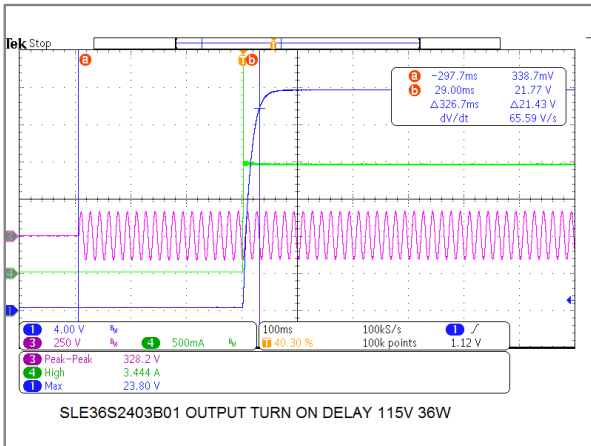

36W/24V Model Turn-On Delay Time

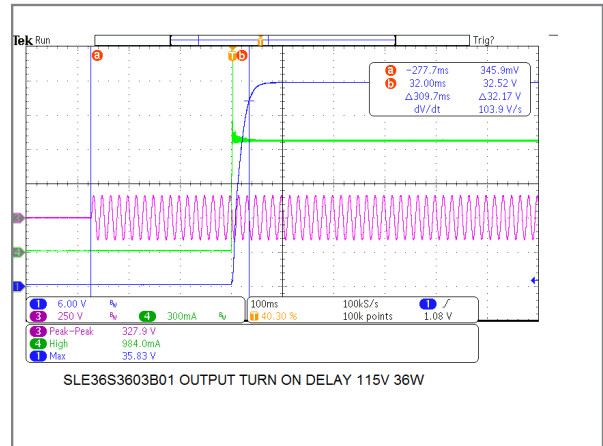

36W/36V Model Turn-On Delay Time

PERFORMANCE DATA

Output Rise Time

The rise time is slightly impacted by line and load. Below are the data plots of the typical output rise time at 115 VAC and full load. The electronic load used for these plots was in constant current mode.

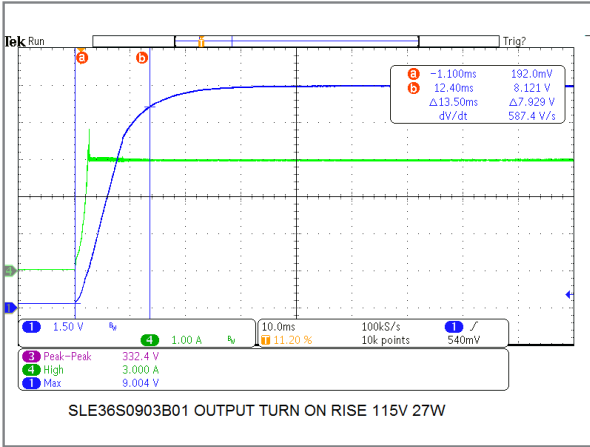

36W/9V Model Output Turn-On Rise Time

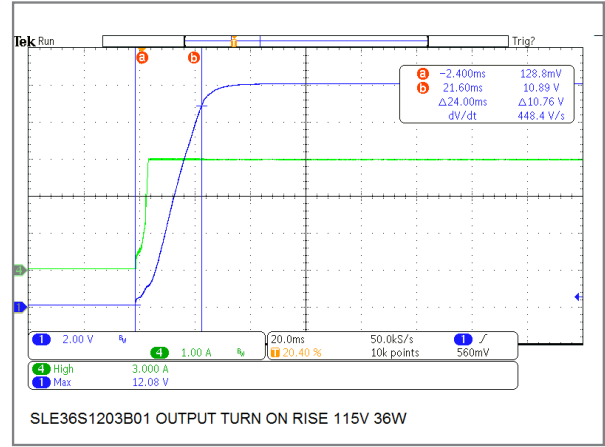

36W/12V Model Output Turn-On Rise Time

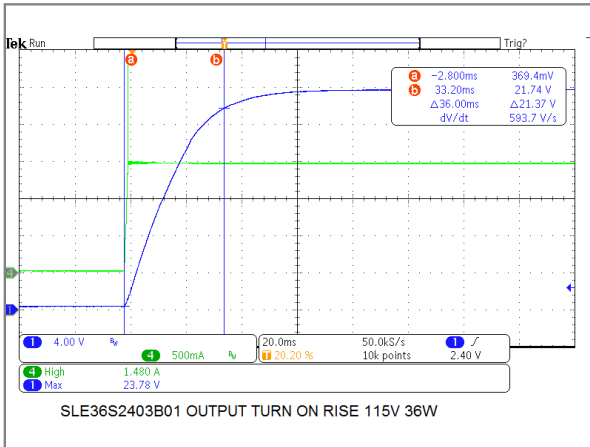

36W/24V Model Output Turn-On Rise Time

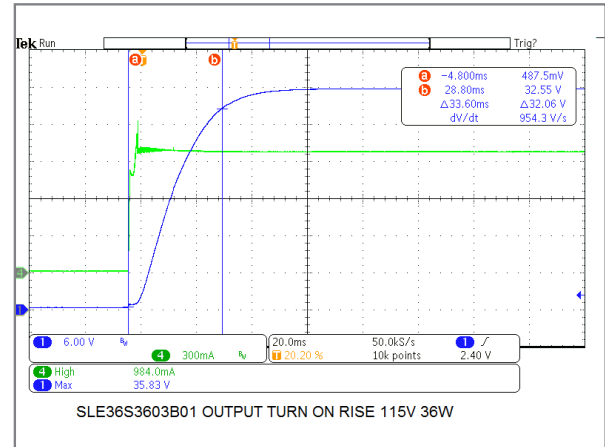

36W/36V Model Output Turn-On Rise Time

PERFORMANCE DATA

Transient Response

The transient response below shows a typical recovery time at 115 VAC and that the output can hold its consistency.

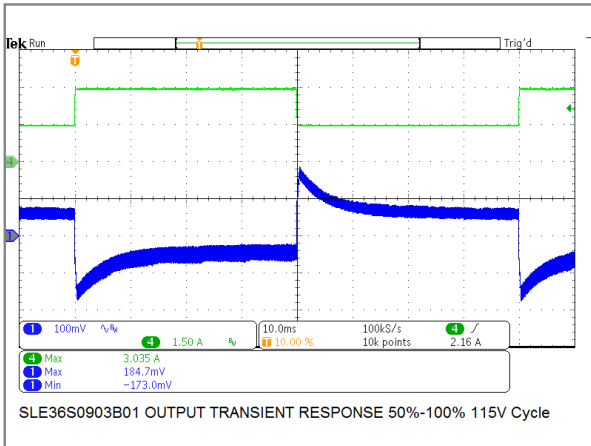

36W/9V Model Transient Response

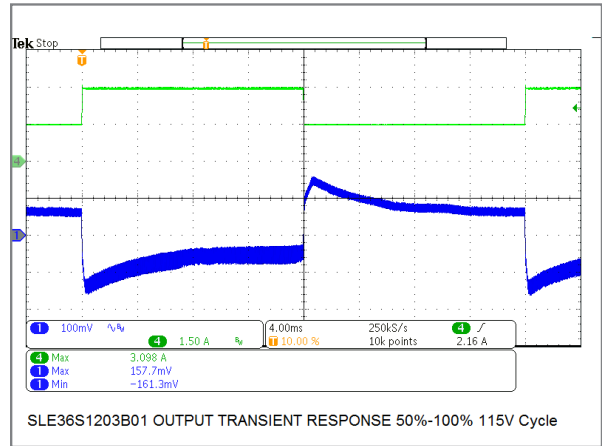

36W/12V Model Transient Response

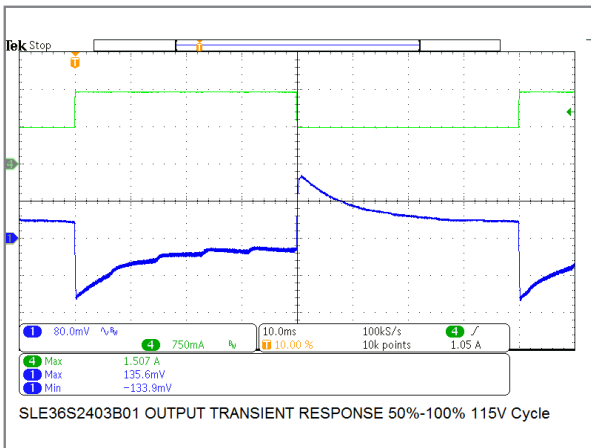

36W/24V Model Transient Response

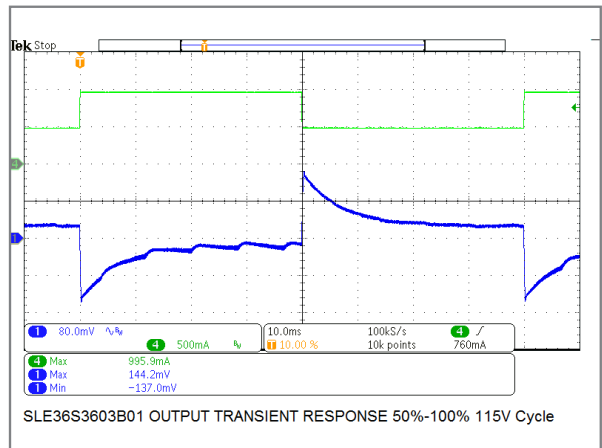

36W/36V Model Transient Response

PERFORMANCE DATA

Output Overload Protection

If the output happens to undergo an overload fault condition it will protect itself by going into a hiccup mode. Hence, it will auto recover when the overload fault condition is no longer present.

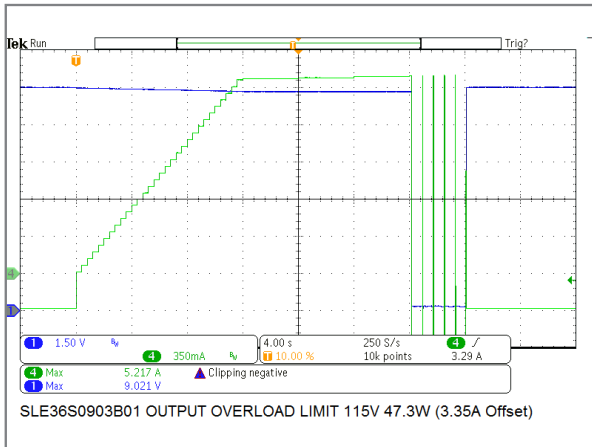

36W/9V Model Output Overload Protection

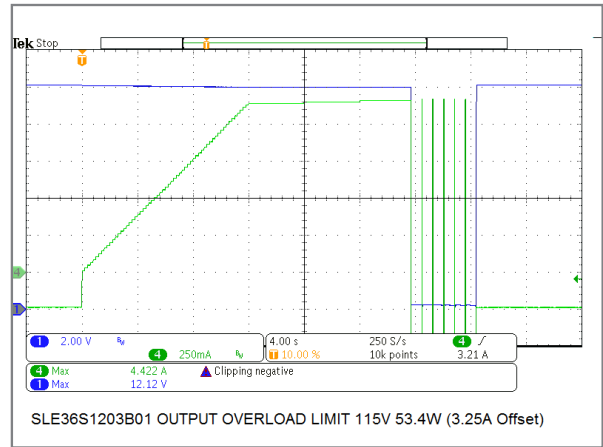

36W/12V Model Output Overload Protection

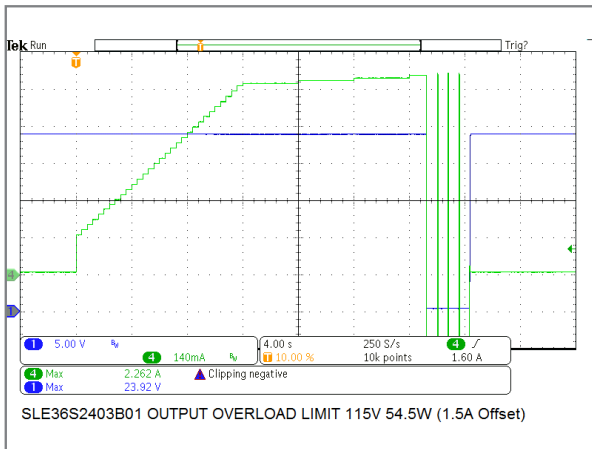

36W/24V Model Output Overload Protection

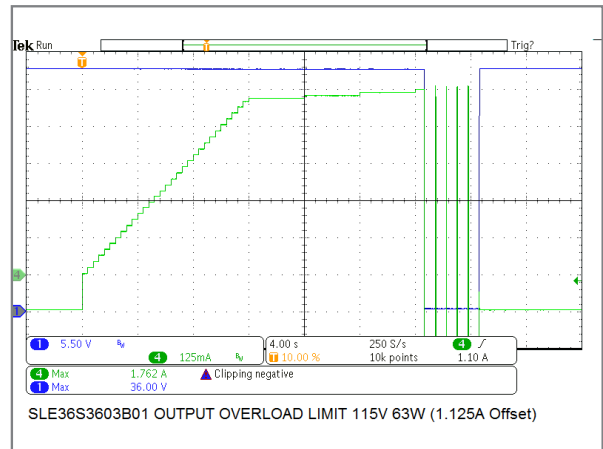

36W/36V Model Output Overload Protection

PERFORMANCE DATA

Output Short Circuit Protection

If the output happens to be short circuit, it will protect itself by going into a hiccup mode. It will auto recover when the short circuit condition has been removed.

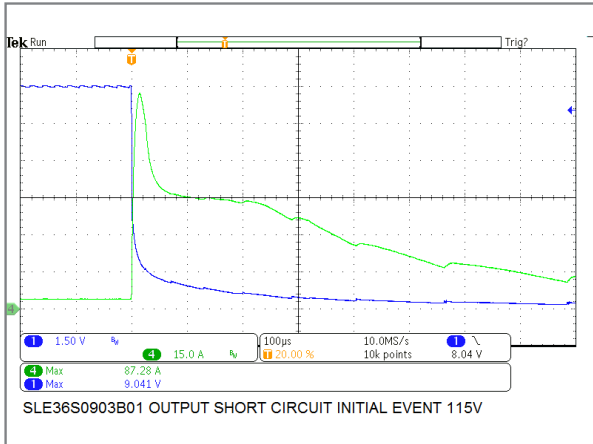

36W/9V Model Output Short Circuit Initial Event

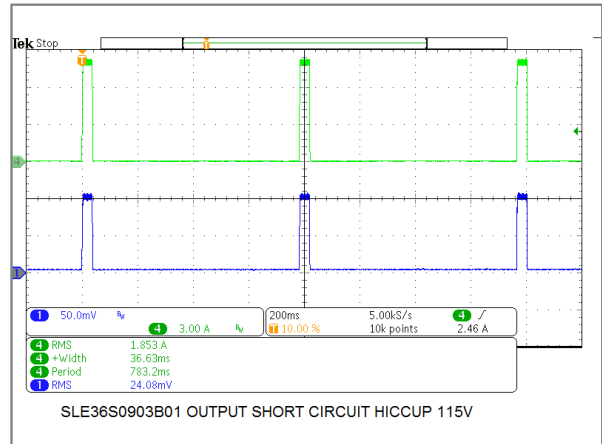

36W/9V Model Output Short Circuit Hiccup Mode

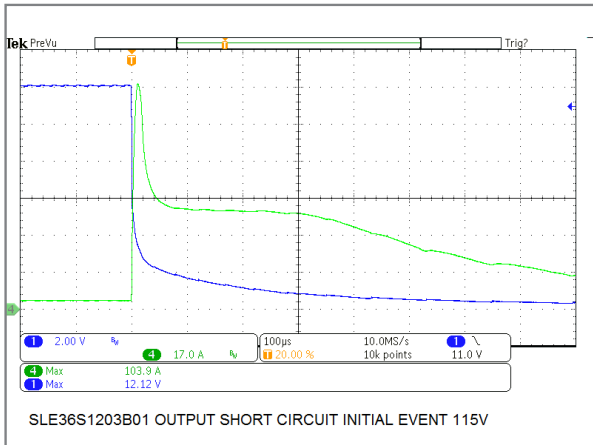

36W/12V Model Output Short Circuit Initial Event

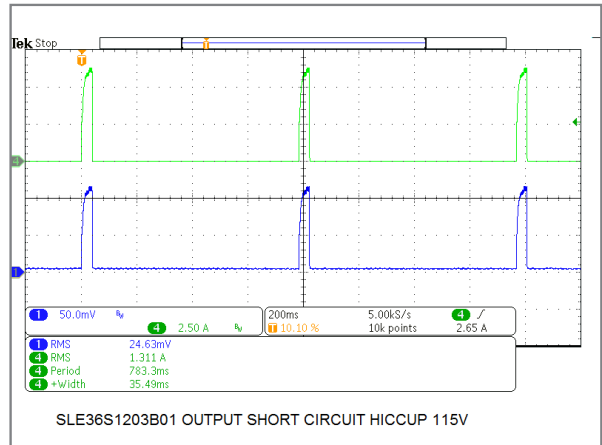

36W/12V Model Output Short Circuit Hiccup Mode



PERFORMANCE DATA

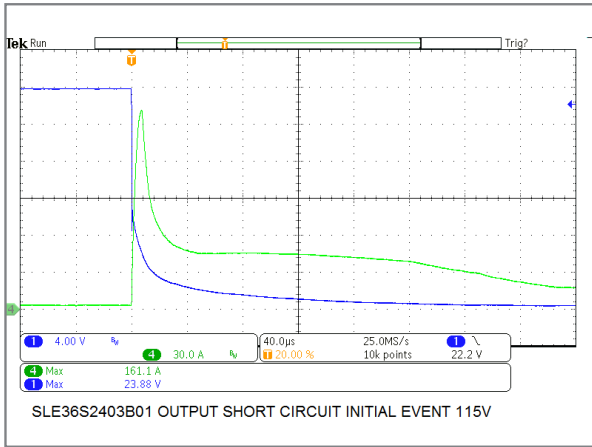

36W/24V Model Output Short Circuit Initial Event

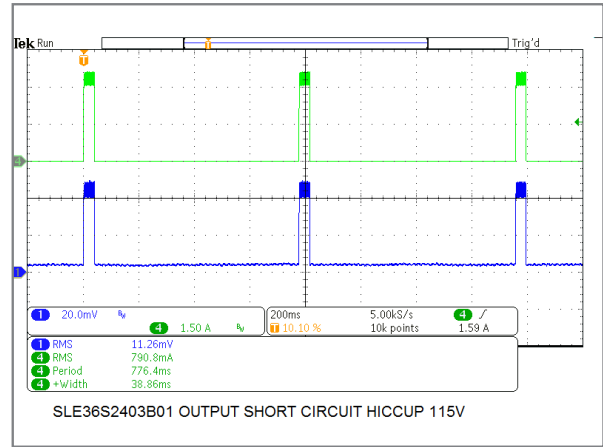

36W/24V Model Output Short Circuit Hiccup Mode

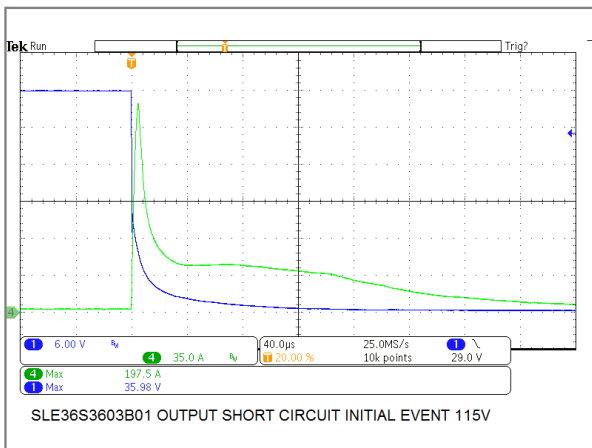

36W/36V Model Output Short Circuit Initial Event

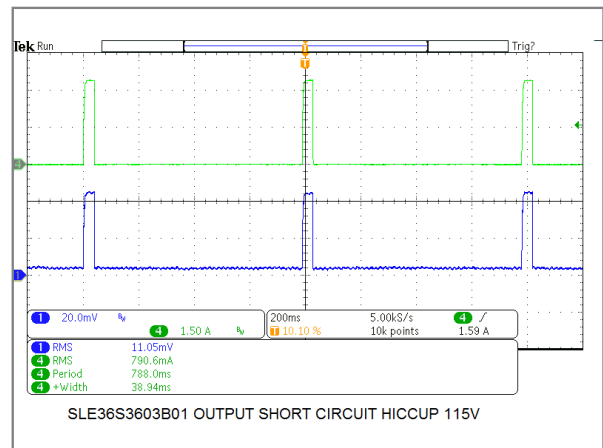

36W/36V Model Output Short Circuit Hiccup Mode

PERFORMANCE DATA

Output Ripple and Noise

This is an inherent ac component of the output voltage due to internal switching, and its amplitude is shown on the plots below and considered to be within an acceptable level.

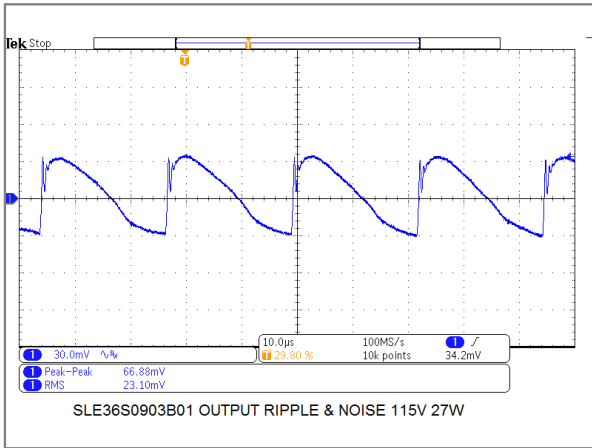

36W/9V Model Output Ripple & Noise at Full Load

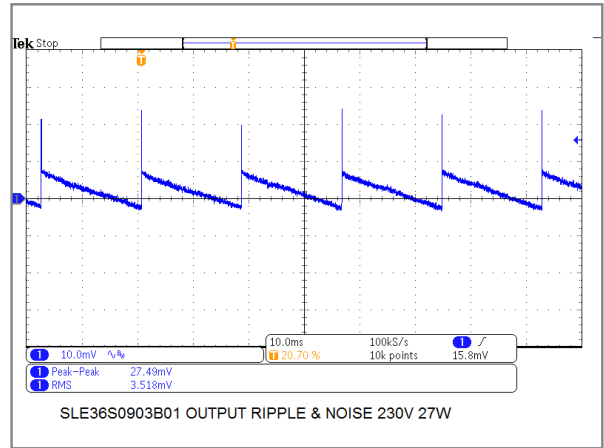

36W/9V Model Output Ripple & Noise at No Load

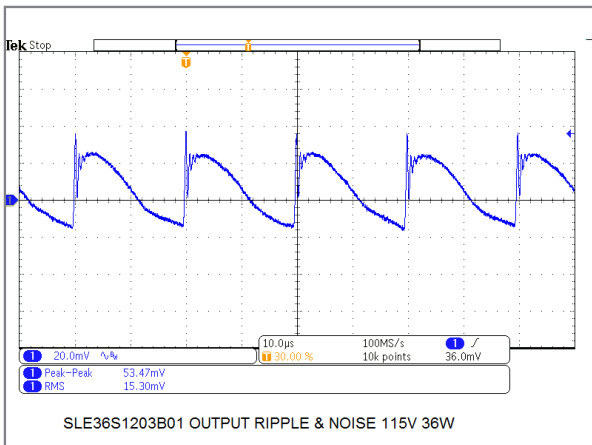

36W12V Model Output Ripple & Noise at Full Load

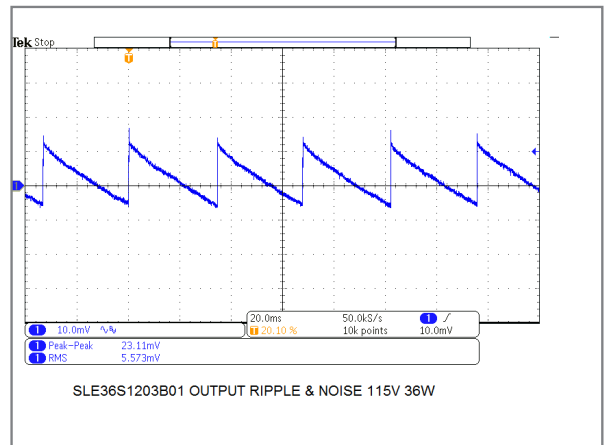

36W/12V Model Output Ripple & Noise at No Load

PERFORMANCE DATA

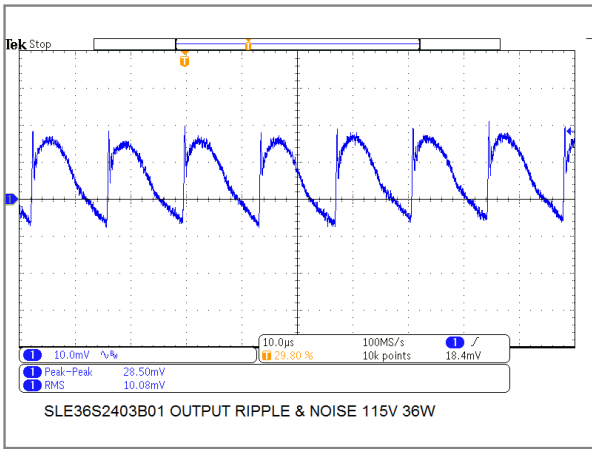

36W/24V Model Output Ripple & Noise at Full Load

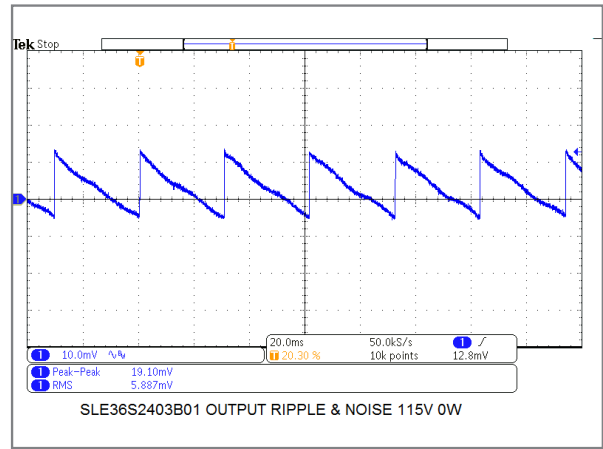

36W/24V Model Output Ripple & Noise at No Load

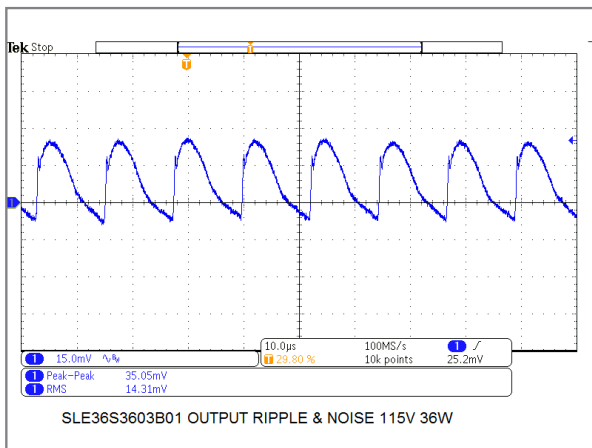

36W/36V Model Output Ripple & Noise at Full Load

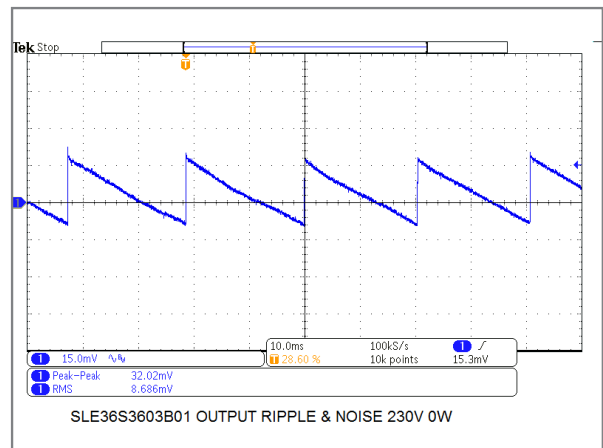

36W/36V Model Output Ripple & Noise at No Load

PERFORMANCE DATA

Efficiency

The ratio of total output power to input power is charted on the plot below in percentage from no load to full load at both nominal line voltage of 115 VAC and 230 VAC for each model.

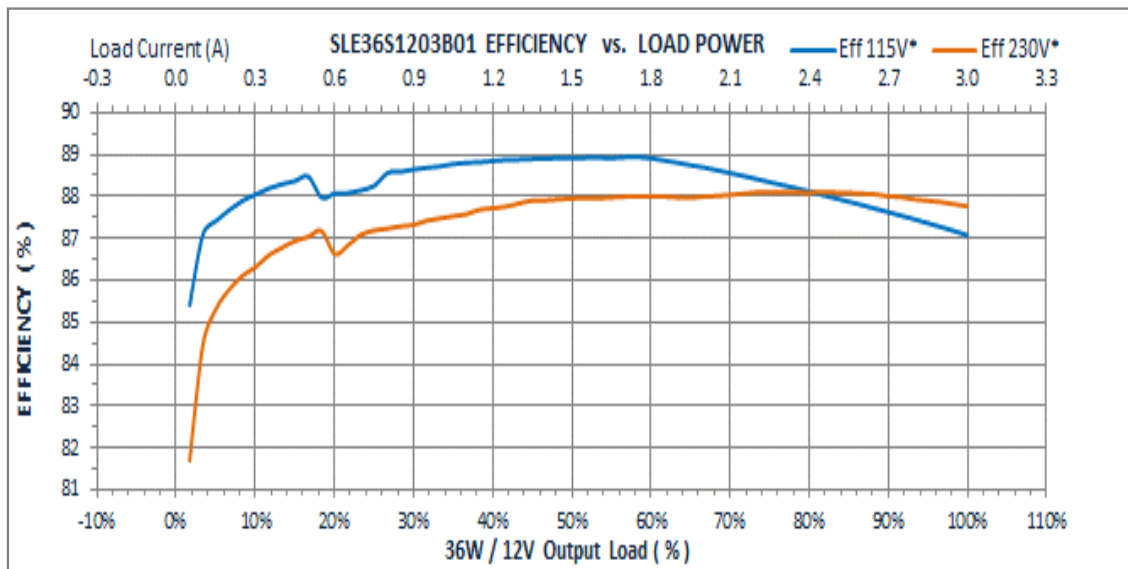
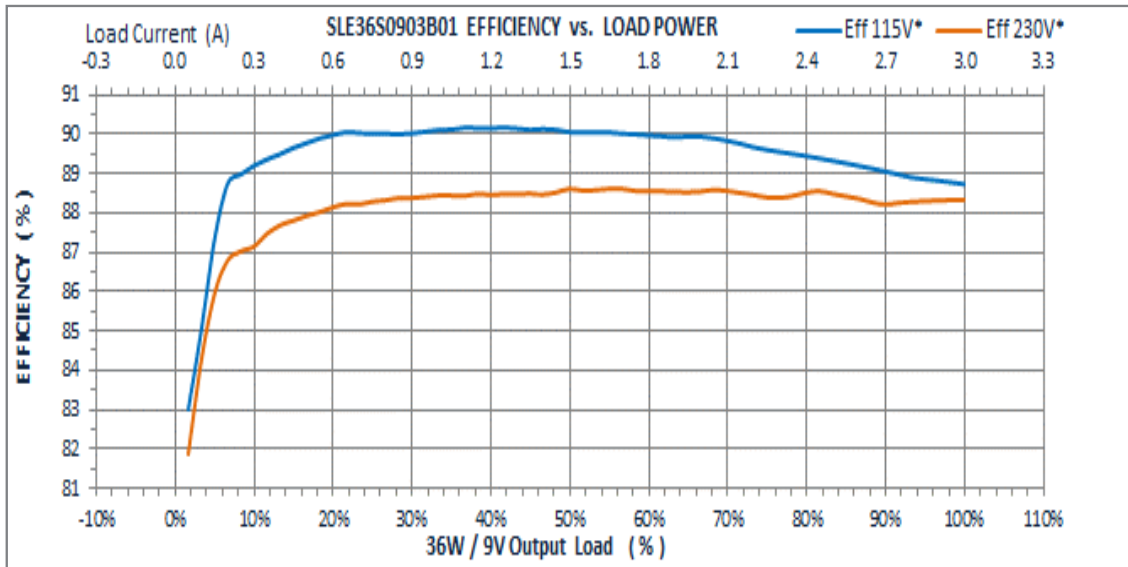

PERFORMANCE DATA

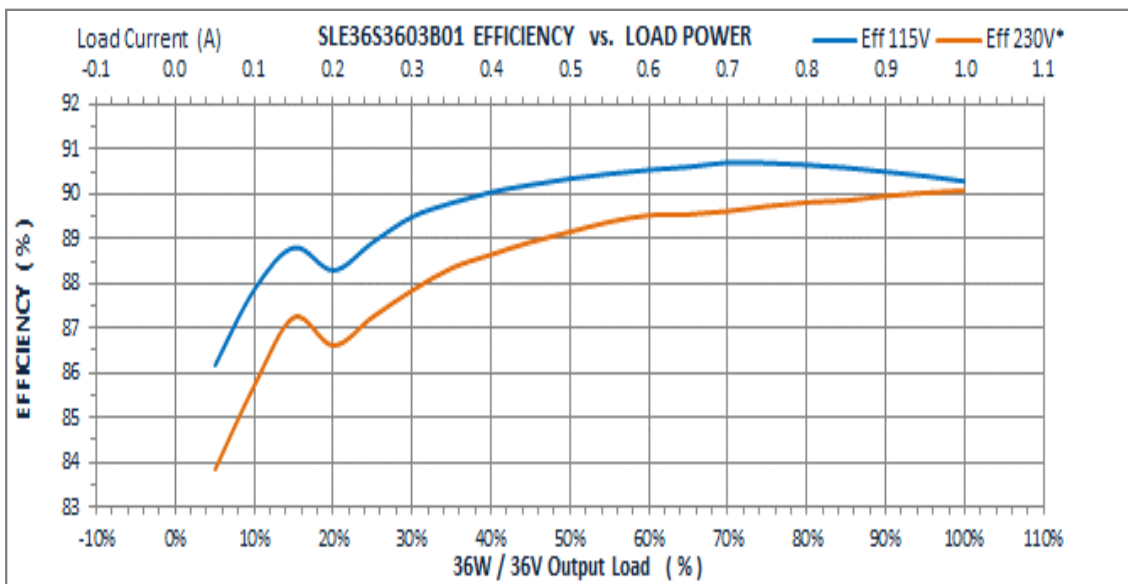
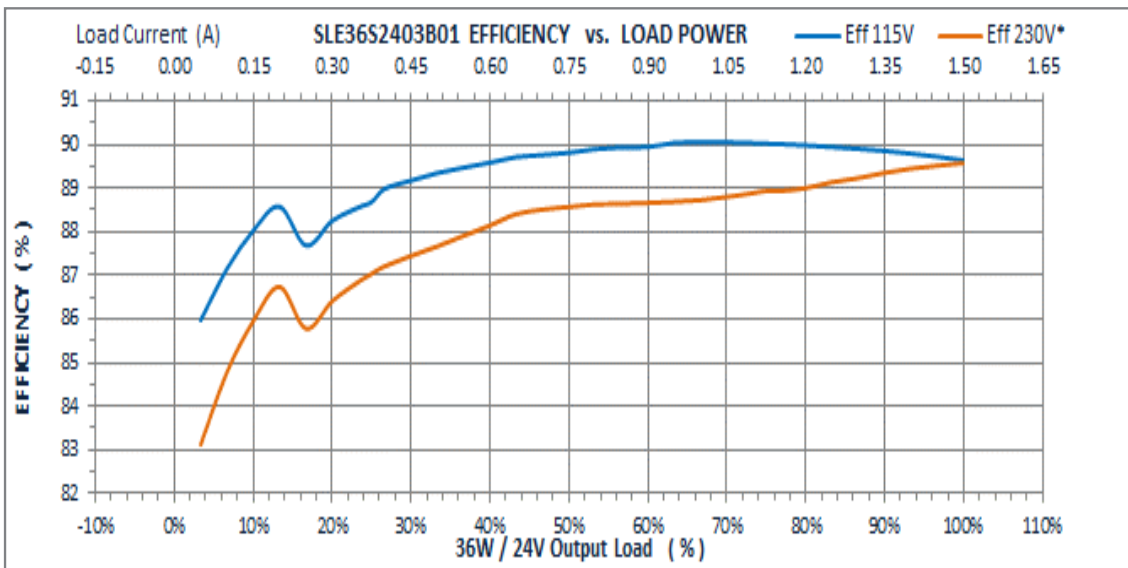

PERFORMANCE DATA

Conducted Electro-magnetic Interference (EMI)

The EMI disturbance generated by the models herein described below are Line and Neutral a 120 VAC/60 Hz and it is within EN 55032 Class B limits with good margin.

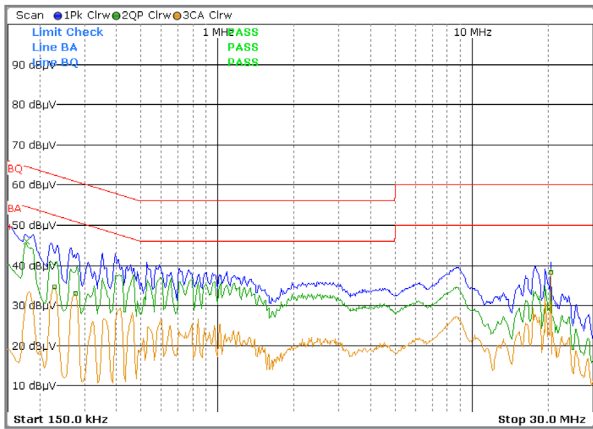

36W/9V Model \_ Line 120V/60Hz 100% 9V@3.0A

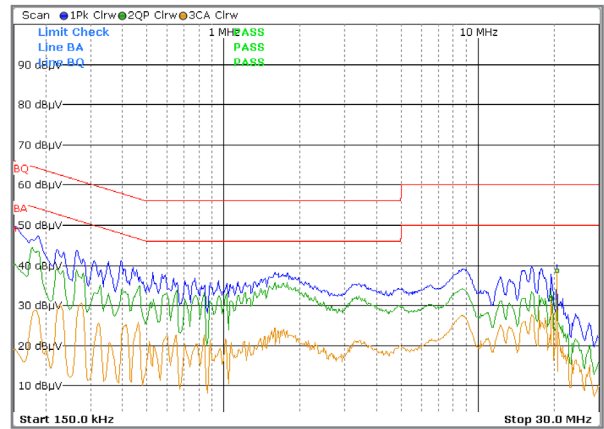

36W/9V Model \_ Neutral 120V/60Hz 100% 9V@3.0A

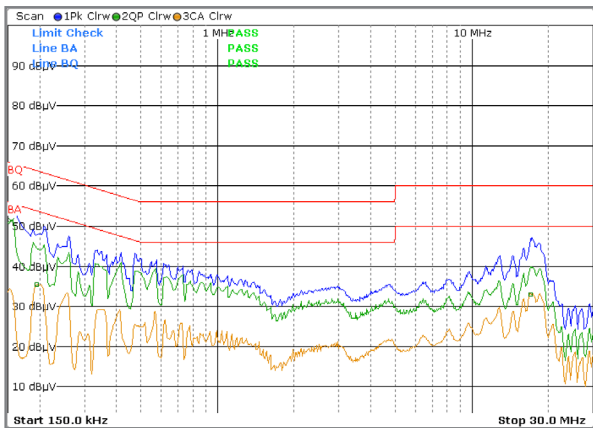

36W/12V Model \_ Line 120V/60Hz 100% 12V@3A

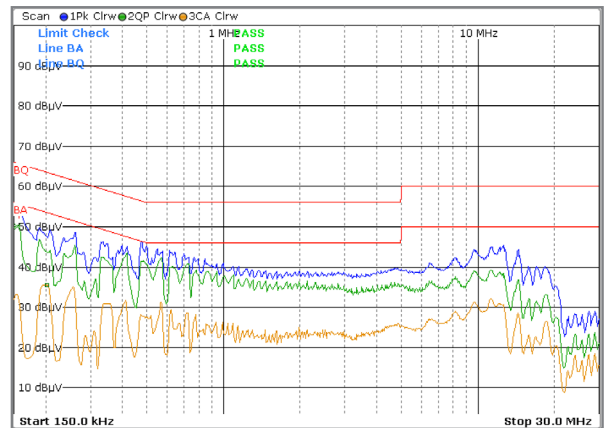

36W/12V Model \_ Neutral 120V/60Hz 100% 12V@3A

PERFORMANCE DATA

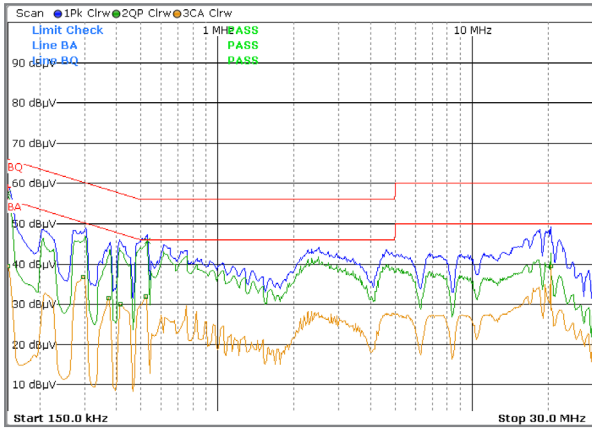

36W/24V Model \_ Line 120V/60Hz 100% 24V@1.5A

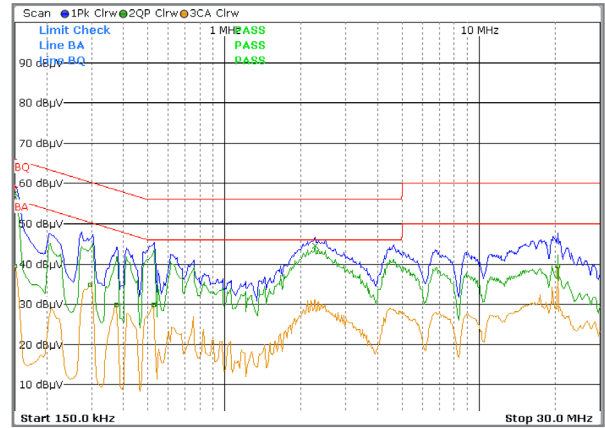

36W/24V Model \_ Neutral 120V/60Hz 100% 24V@1.5A

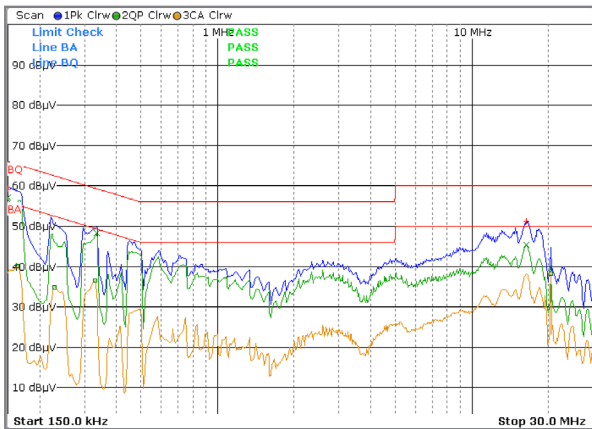

36W/36V Model \_ Line 120V/60Hz 100% 36V@1.0A

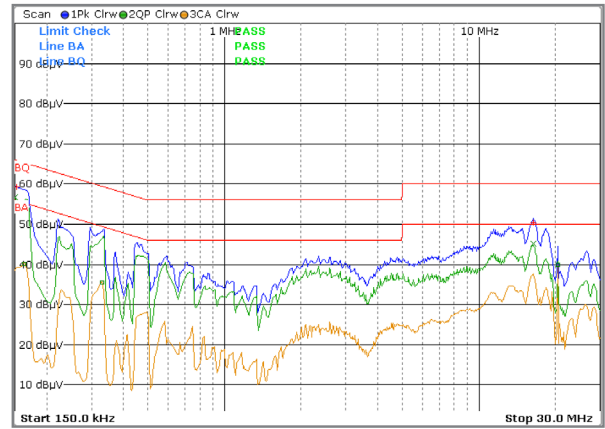

36W/36V Model \_ Neutral 120V/60Hz 100% 36V@1.0A

**RELIABILITY AND ROBUSTNESS**

The external power supply is often handled and not permanently fixed to a structure. It could be dropped on various surfaces, which can cause impact shock damage to the enclosure or internal components. To help assess the potential of damage, shock and vibration requirements should be specified and verified. Low-cost products often use low-cost materials and components that can limit the life of the power supply or result in permanent damage if dropped onto a hard surface.

SL Power provides a higher level of quality and protection to impact shock.

Electrolytic capacitors are one of the main life-limiting components used in the power supply. Selecting high quality capacitors with high-life ratings is essential to achieving long product life in excess of 7 to 10 years. SL Power uses only high-quality electrolytic capacitors in its products. Calculations and measurements are performed to verify capacitor ripple current, voltage and thermal stress and lifetime estimations.

For long-term reliability, this model family uses high quality components to provide long life and have been thoroughly tested and approved by regulatory agencies. See the product datasheet for more details.





For international contact information,  
visit [advancedenergy.com](http://advancedenergy.com).

[powersales@aei.com](mailto:powersales@aei.com) (Sales Support)  
[productsupport.ep@aei.com](mailto:productsupport.ep@aei.com) (Technical Support)  
+1 888 412 7832

## ABOUT ADVANCED ENERGY

Advanced Energy (AE) has devoted more than three decades to perfecting power for its global customers. AE designs and manufactures highly engineered, precision power conversion, measurement and control solutions for mission-critical applications and processes.

Our products enable customer innovation in complex applications for a wide range of industries including semiconductor equipment, industrial, manufacturing, telecommunications, data center computing, and medical. With deep applications know-how and responsive service and support across the globe, we build collaborative partnerships to meet rapid technological developments, propel growth for our customers, and innovate the future of power.

**PRECISION | POWER | PERFORMANCE | TRUST**

---

Specifications are subject to change without notice. Not responsible for errors or omissions. ©2023 Advanced Energy Industries, Inc. All rights reserved. Advanced Energy®, AE® and SL Power™ are U.S. trademarks of Advanced Energy Industries, Inc.