

SL POWER MB120 SERIES

120 Watts Single Output
Medical Grade

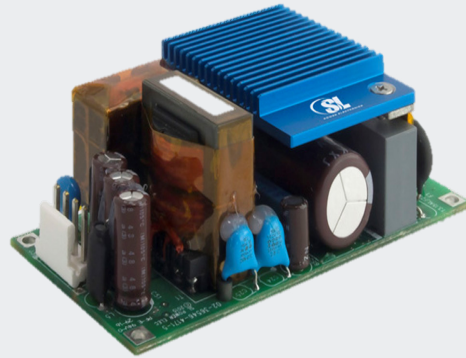

Medical

Advanced Energy's SL Power MB120 family is the latest offering in high density single output open-frame AC/DC power supplies. Approved to EN/CSA/IEC/ES 60601-1, the MB120 family is ideal for industrial and medical applications where power density and cost are critical. The MB120 operates at universal input range of 80 to 264 VAC and wide temperature range -10°C to +70°C, delivering full rated output power up to +50°C.

AT A GLANCE

Total Power

120 Watts

Input Voltage

80 to 264 VAC

of Outputs

Single

SPECIAL FEATURES

- 2"W x 4"L x 1.25"H Size
- For 1U Applications
- Universal Input 80 to 264 VAC
- 120 W w/air, 100 W Convection Cooled
- BF Isolation Type Rated
- 2 x MOPP Isolation
- 10-Year Life Design with Premium E-Caps
- <0.5 W Standby Power
- Approved to EN/CSA/IEC/ES 60601-1
- ROHS Compliant
- 3 Years Warranty

SAFETY

- EN/CSA/IEC/ES 60601-1



ELECTRICAL SPECIFICATIONS

Input	
Input Range	80 to 264 VAC, 47 to 63 Hz, 1Ø (Safety approved to 90 VAC to 264 VAC)
No Load Input Power	< 0.5 W
Inrush Current	40 A max. within a half line cycle, cold start @ 230 VAC input, 25°C
Input Current	115 VAC: 2 A, 230 VAC: 1 A
Input Fuses	3.15 A, 250 VAC fuses provided in both line & neutral
Earth Leakage Current	<150 µA @ 264 VAC, 60 Hz, NC <300 µA @ 264 VAC, 60 Hz, SFC
Patient Leakage Current (Output to Earth)	<90 µA @ 264 VAC, 60 Hz, NC. Suitable for BF rating
Efficiency	92 to 94% typical at 120 VAC / 240 VAC, 25°C
Isolation Voltage	Input/Ground: 4000 VAC, 2 X MOPP Input/Output: 1500 VAC, 1 X MOPP (Class I only) Output/Ground: 1500 VAC, 1 X MOPP (Class I only)
Output	
Maximum Power	120 W continuous with 200 LFM airflow, 100 W convection cooled, -10 to 50°C ambient temperature
Ripple and Noise	1% pk-pk
Total Load Regulation	+/-1%
Minimum Load	Not required
Output Voltage	12 to 24 VDC
Adjustment Range	No voltage adjust potentiometer for higher reliability
Transient Response	500 µs typical, response time for return to within 1% of final value for 25% - 75% - 25% load change
IPC 610	Class II
Reliability	
MTBF	57.25K hrs at 115 VAC / 230 VAC, 25°C telcordia, issue 3, ground benign
E-Cap Life	>10 years in use condition of 40°C ambient, at 12 hours/day, 261 days/year.
Protection	
Overvoltage Protection	Latch off when output voltage is with range as shown in table, requires AC power cycle to reset
Short Circuit Protection	Hiccup mode. No damage will occur if the output is shorted, auto recovery
Thermal Protection	Power shuts down at temperature of 70°C(typical) at full load, without forced air. Hiccup mode, auto recovery
Overload Protection	115% to 180% of rated output current value. Hiccup mode, auto recovery
Output Reverse Voltage Protection	Outputs protected against momentary reverse current less than 20A peak for less than 10 mS with 0.5 A average. Sustained reverse current at high levels may damage unit

SYSTEM TIMING SPECIFICATIONS

Parameter	Min	Typ	Max	Unit
Turn On Time - 115 VAC	-	-	1000	ms
Hold Up Time - 25°C, 100% load	20	-	-	ms
Rise Time - Load dependent	-	-	30	ms

EMI/EMC COMPLIANCE

Conducted Emissions	EN55011/22: Class B, FCC Part 15, Subpart B, Class B, 6db Margin Typical
Radiated Emissions	EN55011/22: Class B, FCC Part 15, Subpart B, Class B 3db Margin Typical
Line Harmonic Emissions	EN61000-3-2, Class A
Voltage Fluctuations & Flicker	EN61000-3-3
Static Discharge Immunity	EN61000-4-2, Level 4, 8kV Contact, 15kV Air Discharge, Criteria A. Also meets proposed IEC60601-1-2 4 th Edition, Table 9
Radiated RF EM Immunity	EN61000-4-3, Level 3, 10 V/m, Criteria A. 80MHz to 1000MHz and 3 V/m 1.4 Ghz to 2.7 Ghz. 80% AM at 1KHz. Also meets proposed IEC60601-1-2 4 th Edition, Table 9
Electrical Fast Transients / Bursts	EN61000-4-4, Level 3, 2 kV, 100 Khz rep rate, 40A(PS output) Criteria A. Also meets proposed IEC60601-1-2 4 th Edition, Table 5&6
Surges Line to Line (DM) and Line to Ground (CM)	EN61000-4-5, Level 3, +/-1kV DM, 2kV CM, Criteria A. Also meets proposed IEC60601-1-2 4 th Edition, Table 5
Conducted Disturbances Induced by RF Fields	EN61000-4-6, 3V/m, 0.15 to 80Mhz and 6V/m in ISM bands between 0.15MHz and 80Mhz. 80% AM at 1Khz
Power Frequency Magnetic Fields Immunity	EN61000-4-8, Level 4 (30A/m), Criteria A. Also meets proposed IEC60601-1-2 4 th Edition, Table 9 enclosure port
Voltage Dips	IEC61000-4-11, 100% dip for 10mS, at 0°, 45°, 90°, 135°, 180°, 225°, 270° and 315°, Criteria A; 60% dip for 100mS, Croteria B; 30% dip for 500mS(25/30 cycles)1Ø, and 0° for 500mS, Criteria A. Also meets proposed IEC60601-1-2 4 th Edition, Table 5
Enclosure Port Immunity to RF wireless communications equipment	EN61000-4-3
Proximity Fields from RF wireless communications Equipment	IEC60601-1-2 4 th Edition, Table 9
Rated Power Frequency magnetic fields	IEC61000-4-8 Level 5, 30A/m, 50/60Hz

Notes:

Performance criteria are based on EN55024. According to the standards, performance criteria are defined as following:

- A - Normal performance during and after the test
- B - Temporary degradation, self-recoverable
- C - Temporary degradation, operator intervention required to recover the operation
- D - Permanent damage

SAFETY

DEMKO	EN60601-1:2006
CSA	CAN/CSA-C22.2 No. 60601-1 (2005)
IEC	IEC60601-1 3 rd Edition
ANSI/AAMI	ES60601-1 (2008)
China Safety	GB4943. 1-2011 at 3Km, Tropical Standard at 40°C, 93% RH at 120 hours

ENVIRONMENTAL SPECIFICATIONS

Operating Temperature	-10°C to +70°C, turn on temperature is -20°C when input voltage >=115 VAC, allowing 30 seconds with 50% to 100% load for stabilization
Storage Temperature	-40°C to +85°C
Temperature Derating	Derate output power above 50°C to 50% at 70°C
Relative Humidity	5% to 95%, non-condensing
Altitude	Operating: -500 to 3000 m. Non-operating: -500 to 40,000 ft
Shock	Operating: Half-sine shock waveform. Impact Acceleration: 20g, Pulse duration: 11mS. Cycles: 3 times per axis in X,Y, Z direction Non-Operating: Half-sine shock waveform. Impact Acceleration: 40g, Pulse duration: 6mS Cycles: 3 times per direction on 3 axes (X, Y, Z)
Vibration	Operating: Sinusoidal Frequency: 10 to 500Hz, Impact Acceleration: 1g, Sweep rate: 1 octave/min Cycles: 10 times per axis in X, Y, Z direction Random Vibration: Operating: 0.003 g ² /Hz, 1.224 grams overall, 3 axes, 10 min/axis, 1Hz–500Hz. Non-Operating: 0.02g ² /Hz, 3.1 grams overall, 3 axes, 1 hr/axis, 20Hz–500Hz
Weight	225 g, typical

ORDERING INFORMATION

Model Number ¹	Output Voltage	Output Current		Efficiency ²	Ripple & Noise ³	Initial Set Point	Total Regulation	OVP Threshold
		200 LFM air	Convection					
MB120S12K01	12 V	10.0 A	8.3 A	92%	1%	+/-2%	+/-1%	14.4 ± 1.2 V
MB120S15K01	15 V	8.0 A	6.6 A	93%	1%	+/-2%	+/-1%	18.0 ± 1.5 V
MB120S18K01	18 V	6.6 A	5.5 A	94%	1%	+/-2%	+/-1%	21.6 ± 1.8 V
MB120S24K01	24 V	5.0 A	4.1 A	94%	1%	+/-2%	+/-1%	28.8 ± 2.4 V
MB120S12C01	12 V	10.0 A	8.3 A	92%	1%	+/-2%	+/-1%	14.4 ± 1.2 V
MB120S15C01	15 V	8.0 A	6.6 A	93%	1%	+/-2%	+/-1%	18.0 ± 1.5 V
MB120S18C01	18 V	6.6 A	5.5 A	94%	1%	+/-2%	+/-1%	21.6 ± 1.8 V
MB120S24C01	24 V	5.0 A	4.1 A	94%	1%	+/-2%	+/-1%	28.8 ± 2.4 V

Notes:

1. Replace the "K" in teh part number to "C" for Class II input.
2. Efficiency typical at 230 VAC, 25°C. See charts below for load conditions.
3. Measured at 25°C using 6 inch twisted pair wires with noise probe directly across output terminals, and load terminated with 0.1µF ceramic and 10µF low ESR capacitors.

CONNECTOR INFORMATION

Type	Connector	Pin #	Assignment	Connector	Mating Connector
INPUT	J1	1	AC Line	TE-Connectivity 641937	Connector: TE-Connectivity 640250-3 Pin: TE-Connectivity 640252-2
		2	AC Neutral		
OUTPUT	J3	1	-Vout	TE-Connectivity 640445-4	TE-Connectivity 640250-4 Pin: TE-Connectivity 640252-2
		2	-Vout		
		3	+Vout		
		4	+Vout		

MECHANICAL DRAWING

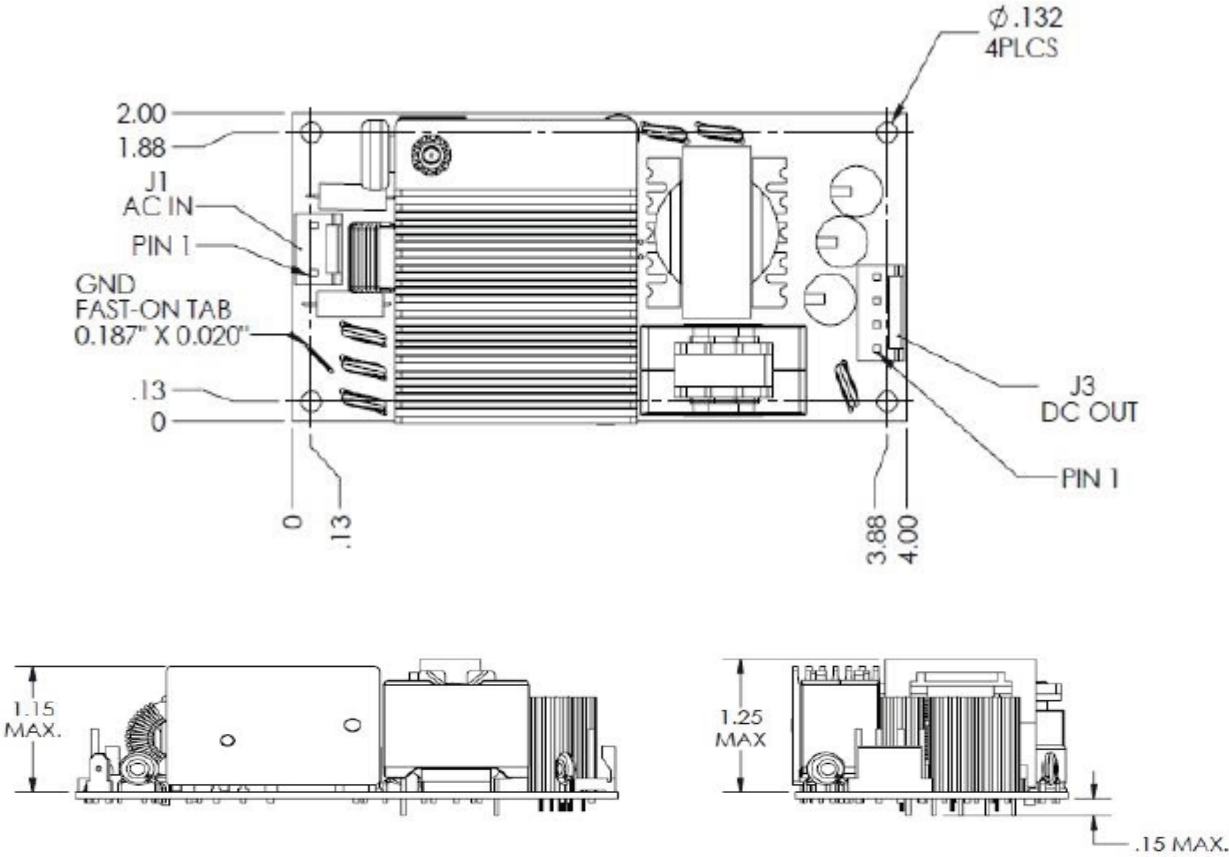

- Notes:
1. All dimensions in mm (inches).
 2. Dimensions: W: 2" x L: 4" x H: 1.25".
 3. Unit weight: 225 g.

DERATING CURVES

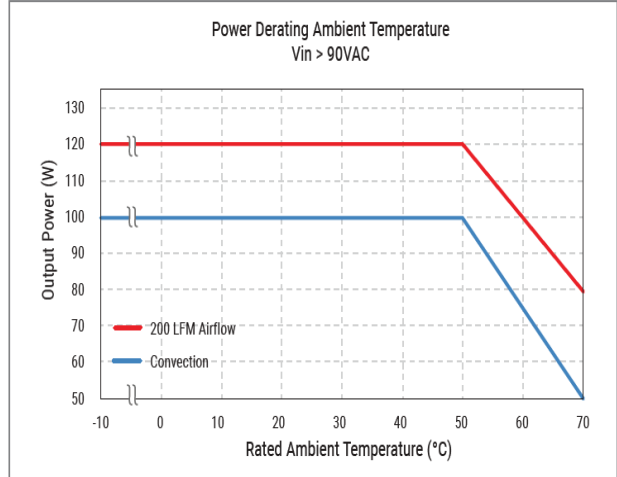
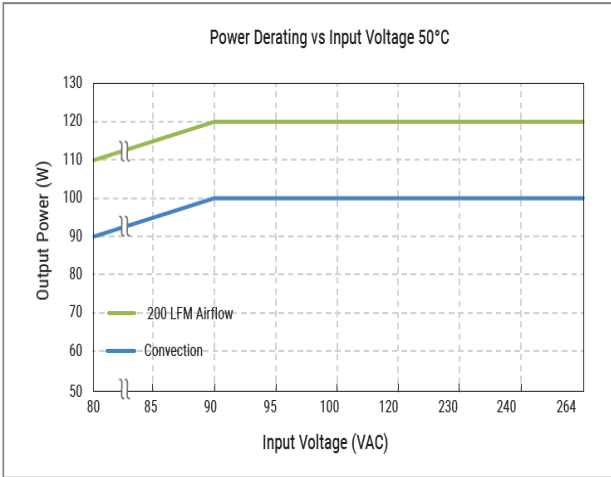

EFFICIENCY INFORMATION

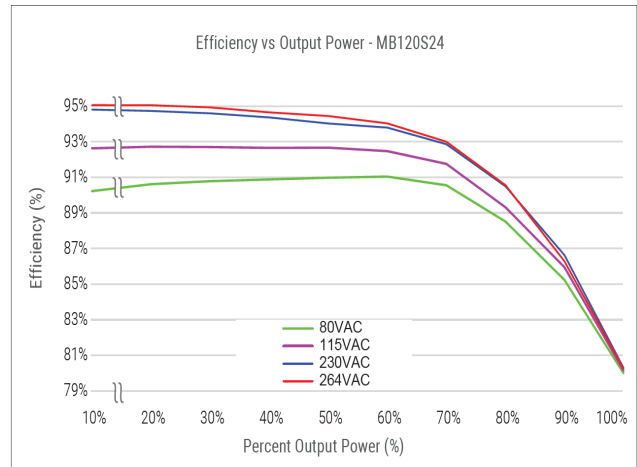
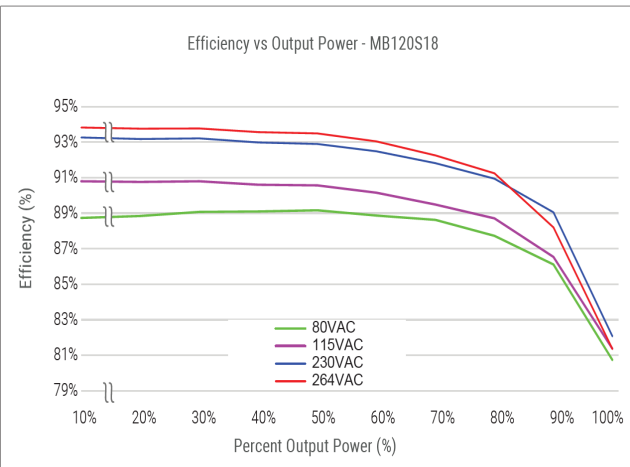
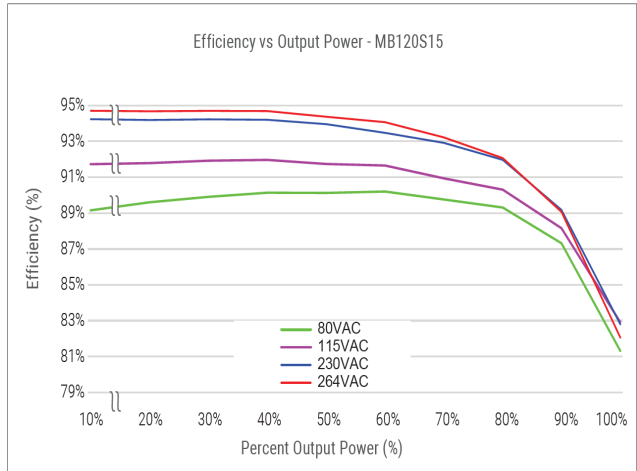
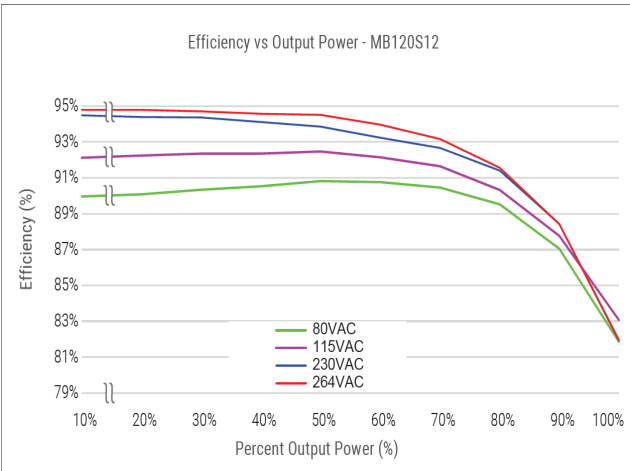



For international contact information,
visit [advancedenergy.com](https://www.advancedenergy.com).

powersales@aei.com (Sales Support)
productsupport.ep@aei.com (Technical Support)
+1 888 412 7832

ABOUT ADVANCED ENERGY

Advanced Energy (AE) has devoted more than three decades to perfecting power for its global customers. AE designs and manufactures highly engineered, precision power conversion, measurement and control solutions for mission-critical applications and processes.

Our products enable customer innovation in complex applications for a wide range of industries including semiconductor equipment, industrial, manufacturing, telecommunications, data center computing, and medical. With deep applications know-how and responsive service and support across the globe, we build collaborative partnerships to meet rapid technological developments, propel growth for our customers, and innovate the future of power.

PRECISION | POWER | PERFORMANCE | TRUST

Specifications are subject to change without notice. Not responsible for errors or omissions. ©2023 Advanced Energy Industries, Inc. All rights reserved. Advanced Energy®, and AE® are U.S. trademarks of Advanced Energy Industries, Inc.